

KOBELCO



**Essential Factors in Gas
Shielded Metal Arc Welding**

KOBE STEEL, LTD.

KOBELCO



Essential Factors in Gas Shielded Metal Arc Welding

KOBE STEEL, LTD.

Published by **KOBE STEEL, LTD.**

© 2015 by **KOBE STEEL, LTD.**

5-912, Kita-Shinagawa, Shinagawa-Ku, Tokyo
141-8688 Japan

All rights reserved. No part of this book may be reproduced, in any form or by any means, without permission in writing from the publisher.

The *Essential Factors in Gas Shielded Metal Arc Welding* provides information to assist welding personnel study the arc welding technologies commonly applied in gas shielded metal arc welding.

Reasonable care is taken in the compilation and publication of this textbook to insure authenticity of the contents. No representation or warranty is made as to the accuracy or reliability of this information.

Introduction

Nowadays, gas shielded metal arc welding (GSMAW) is widely used in various constructions such as steel structures, bridges, autos, motorcycles, construction machinery, ships, offshore structures, pressure vessels, and pipelines due to high welding efficiency. This welding process, however, requires specific welding knowledge and techniques to accomplish sound weldments. The quality of weldments made by GSMAW is markedly affected by the welding parameters set by a welder or a welding operator. In addition, how to handle the welding equipment is the key to obtain quality welds. The use of a wrong welding parameter or mishandling the welding equipment will result in unacceptable weldments that contain welding defects. The *Essential Factors in Gas Shielded Metal Arc Welding* states specific technologies needed to accomplish GSMAW successfully, focusing on the welding procedures in which solid wires and flux-cored wires are used with shielding gases of CO₂ and 75-80%Ar/bal.CO₂ mixtures (GSMAW with Ar-CO₂ mixed gases is often referred to as MAG welding to distinguish it from CO₂ welding). In accordance with the AWS standard, GSMAW with solid wires is designated as gas metal arc welding (GMAW), whereas GSMAW with flux-cored wires, as flux cored arc welding (FCAW). GSMAW processes are popularly used for welding various kinds of metals such as mild steel, high strength steel, low temperature steel, heat-resistant low-alloy steel, and stainless steel; however, this textbook has been edited with focus on mild steel, high strength steel, and low-temperature steel, in which as many figures and photographs are employed as possible in order to help the beginners fully understand the specific technologies for GSMAW. The information contained in this textbook includes those from the references listed below.

References

- (1) The Japan Welding Society, "CO₂ Semi-automatic Arc Welding," 1986, Sanpo Publications Inc.
- (2) The Japan Welding Society, "Q&A on MAG/MIG Arc Welding," 1999, Sanpo Publications Inc.
- (3) Kobe Steel, Ltd., "How to Use Solid Wires in Gas Metal Arc Welding," 1995
- (4) American Welding Society, "Welding Handbook," Eighth Edition, Vol. 2, 1991
- (5) The Japan Welding Society, "Advanced Welding and Joining Technologies," 2008, Sanpo Publications Inc.

Contents

1. Principles of Gas Shielded Metal Arc Welding	1
2. Fundamental Procedures for GSMAW	1
3. Essential Factors in GSMAW	7
3.1 Power sources and accessories	7
3.1.1 Power source varieties and basic characteristics	7
3.1.2 Duty cycle and permissible currents	8
3.1.3 Welding cables and voltage drop	10
3.2 Welding wires	11
3.2.1 Types of solid wires	11
3.2.2 Types of flux-cored wires	13
3.3 Welding Practice	14
3.3.1 Droplet transfer modes and applications	14
3.3.2 Welding parameters and weld quality	19
3.3.3 How to ensure the shielding effect	22
3.3.4 How to ensure good wire feeds and stable arcs	24
3.3.5 Electrode orientations and applications	26

1. Principles of Gas Shielded Metal Arc Welding

The gas shielded metal arc welding (GSMAW) process configuration consists of several components and consumables as arranged in **Fig. 1-1**. The main components and consumables are (1) welding power source, (2) remote controller, (3) wire feeder, (4) welding torch, (5) shielding gas cylinder and regulator, and (6) welding wire; in addition, a water circulator for a water-cooled welding torch (not included in the figure). **Figure 1-2** shows an overall view of power source, wire feeder, and welding torch. With the GSMAW process using a constant-voltage power source, the electrode wire is fed at a constant speed that matches the welding current while the arc length is remained almost constant by the self-correction mechanism of the power source. The electrode wire is fed into the arc through the wire feeder, conduit tube, and welding torch. During welding, the arc and molten pool are shielded with a shielding gas to prevent them from the adverse effects of nitrogen and oxygen in the atmosphere. The type of welding wire chooses the proper kind of shielding gas to ensure intended usability and weldability; however, the wires for mild steel and high strength steel mostly use CO₂ and 75-80%Ar/bal.CO₂ mixtures for general applications.

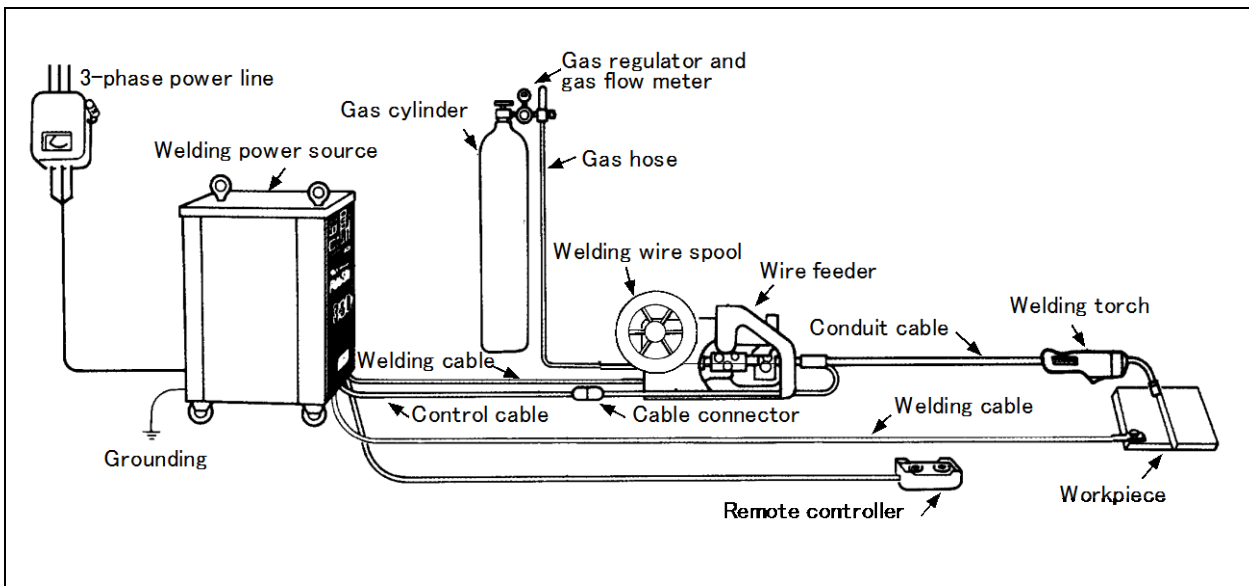

Fig. 1-1 Typical arrangement of the gas shielded metal arc welding process
(Source: a brochure of DAIHEN Corp.)

2. Fundamental Procedures for GSMAW

After it is confirmed that electrical connection and shielding gas passage connection (and water-cooling circuit connection for a water-cooled welding torch) are correctly completed, follow the fundamental procedures as summarized in **Table 2-1** to prepare GSMAW. The keynotes of the table provide useful instructions for preparing the equipment, tools, and welding consumables and for setting the welding parameters to conduct GSMAW successfully.



Fig. 1-2 A set of welding power source, wire feeder, and welding torch
(Source: a brochure of Kobe Steel, Ltd.)

Table 2-1 Fundamental procedures for GSMAW

Step	Keynote
<p>1. Confirm the contact tip</p>	<p>(a) Confirm the inner-diameter indication on the contact tip matches the diameter of the welding wire to be used and the bore of the contact tip is not deformed by abrasion.</p> <p>(b) Confirm the contact tip is firmly fastened in place so that welding currents can surely be conveyed from the contact tip to the welding wire during welding.</p> <div data-bbox="446 425 1372 616" data-label="Diagram"> </div> <p>Fig. 2-1 Arrangement of a contact tip in an air-cooled GSMAW torch</p>
<p>2. Confirm the feed roller</p>	<p>(a) Confirm the groove size of the feed roller matches the diameter of the welding wire to be used.</p> <p>(b) If the groove of the feed roller is worn out, replace it with a new one.</p> <div data-bbox="638 817 1101 1142" data-label="Image"> </div> <p>Fig. 2-2 Arrangement of a feed roller in a wire feeder</p>
<p>3. Turn on the power switches</p>	<p>(a) Confirm the main switch of the power source is turned off, and turn on the main switch of the power line switchboard.</p> <p>(b) Confirm the torch switch is turned off, and turn on the main switch of the power source, then confirm the power pilot lamp turns on.</p> <p>(c) Confirm the blower of the power source rotates smoothly.</p> <div data-bbox="494 1433 1260 1758" data-label="Diagram"> </div> <p>Fig. 2-3 A typical control panel of a GSMAW power source</p>

4. Adjust the flow rate of a shielding gas

- (a) Confirm the shielding gas regulator is fitted in the correct position and the built-in heater is working, before opening the main cock of a shielding gas cylinder.
- (b) Adjust the pressure of the shielding gas to be 0.2-0.3 MPa by controlling the pressure regulation knob of the shielding gas regulator.
- (c) Turn the gas check switch to the "Check" position on the control panel of the power source (See Fig. 2-3), and adjust the flow rate of the shielding gas by controlling the knob on the gas flow meter according to the standard rates shown below.
- (d) Return the gas check switch to the "Welding" position.

Table 2-2 — Proper flow rates of shielding gases

Welding current (A)	Gas flow rate (liter/min)
100 - 200	15 - 25
200 - 300	20 - 30
300 - 500	20 - 30

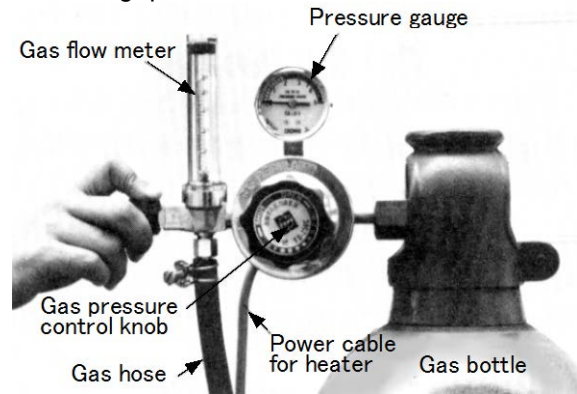

Fig. 2-4 A gas regulator

Note:

Moisture and other impurities contained in a shielding gas can cause welding defects. Therefore, shielding gases must have a sufficiently high purity. CO₂ gas should be as pure as 99.8 vol% or higher, and Ar gas should be as pure as 99.99 vol% or higher, containing as low moisture as specified. (Refer to JIS Z 3253:2011, Shielding Gases for Fusion Welding and Thermal Cutting)

5. Set a welding wire on the spindle

- (a) Set a specified welding wire onto the spindle of the wire feeder so that the tip of the spooled wire can be taken out under the spool toward the feed roller, and set the spool stopper.
- (b) When handling a spooled wire, take the correct way as shown below. The wrong way causes deformation of the flange of the spool and may cause the wire insertion between layers of wires, which finally may cause the wire jamming during welding.

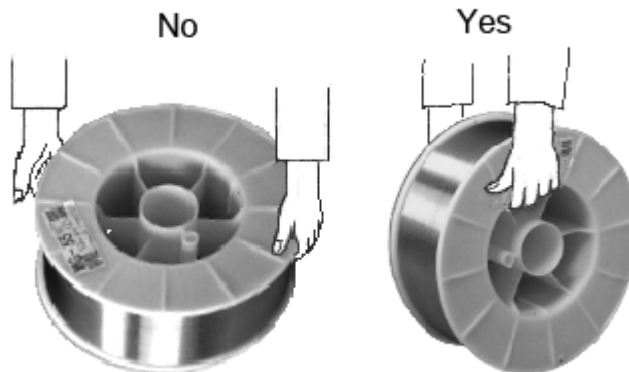

Fig. 2-5 A correct way (Right) and a wrong way (Left) of lifting a spool of wire

<p>6. Engage the wire with the feed roller</p>	<p>(a) Take off the tip of the spooled wire from the stopper hole, cut off the tip, holding the wire by hand, and straighten a certain length of the wire by hand for easier guidance to the wire inlet guide. Lead the wire into the wire inlet guide through the feed roller, and confirm the wire aligns with the groove of the feed roller. Set the pressure arm down onto the wire to engage the wire with the feed roller.</p> <p>(b) Adjust the pressure on the wire by controlling the pressure-adjusting knob according to the size and material of the wire to be used. Excessive pressure causes deformation of the wire and flakes of the wire between the feed roller and the pressure roller, thereby causing irregular wire feeding. In contrast, too weak pressure causes slipping of the wire, thereby causing unstable wire feeding. (Different types of wire feeders may use different ways of controlling the pressure; so follow the individual specification.)</p> <div data-bbox="555 589 1268 1055" data-label="Diagram"> </div> <p>Fig. 2-6 Alignment of the straightening roller, feed roller, wire inlet guide, and a welding wire (Note: Wire straightening rollers are needed particularly for automatic and robotic welding)</p>
<p>7. Feed the wire into the welding torch</p>	<p>(a) By turning on the inching switch of the remote controller, feed the wire through the welding torch until the wire extends approximately 20 mm from the tip of the contact tube.</p> <p>(b) Confirm the wire is fed smoothly. If the wire feeding is not smooth, check whether or not the pressure roller properly presses the wire, the feed roller and the wire are aligned, and the wire spool is smoothly rotated.</p> <div data-bbox="534 1444 1268 1691" data-label="Image"> </div> <p>Fig. 2-7 A remote controller for a GSMAW power source</p>
<p>8. Adjust the straightness of the wire</p>	<p>(a) Adjust straightness of the wire by controlling the adjusting screw of the swing arm (Refer to Fig. 2-6) to feed the wire properly straight (with slight curvature) from the contact tip and to decrease the feeding resistance of the wire passage. (Different types of wire feeders may use different methods of adjusting the straightness; so follow the individual specification.)</p>

9. Adjust welding current and voltage

(a) Adjust the welding current and voltage by controlling the welding-current adjusting knob and the arc-voltage adjusting knob of the control panel of the power source or of the remote controller. (Refer to **Figs. 2-3** and **2-7**) Proper welding current and arc voltage depend on the size of wire, thickness of base metal, and welding position.

With a power source having the A-V automatic control system, the arc voltage is automatically adjusted when the welding current is set, according to the pre-set A-V relationship. More fine adjustment can be done by using the voltage fine-adjusting knob.

Note:

If the voltage is set too low, the welding wire sticks onto the base metal making crackling sounds with an irregular arc. If the voltage is set too high, the arc becomes a long flame causing much spatter generation. When the arc voltage is properly adjusted, the arc is stable with little spatter generation.

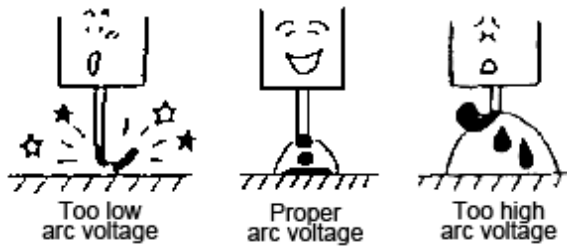

Fig. 2-8 Adjustment of proper arc voltage

10. Hold the welding torch in the proper position and start welding

(a) Hold the welding torch in the proper position suitable for controlling the molten pool, maintaining a stable arc and good gas-shielding.

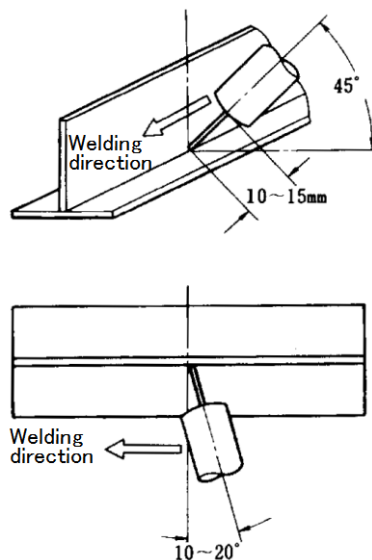
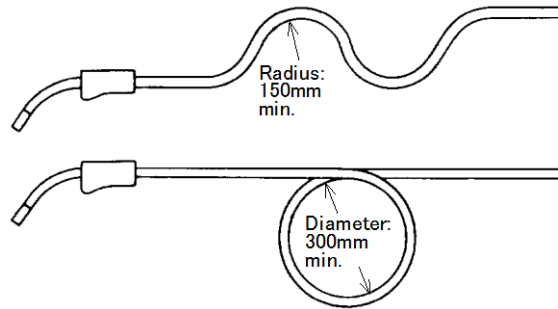

Fig. 2-9 Proper positioning of the welding torch in horizontal-fillet welding

(b) Confirm the conduit cable has no sharp bend of small radius because a sharp bend of the conduit cable causes irregular wire feeding, thereby causing an irregular arc. The permissible minimum bend is approximately 150-mm radius for a curvature, or 300-mm diameter for a circle as shown in **Fig. 2-10**.

Fig. 2-10 Permissible minimum radius of a curvature and diameter of a circle in a conduit cable line to prevent irregular wire feeding and an unstable arc



- (c) Hold the welding torch so that the tip of the wire is close to the base metal, turn on the torch switch to feed the shielding gas and welding wire, then an arc starts when the wire touches the workpiece. While the welder holds the torch switch (turned on) the arcing continues, and when the welder releases the torch switch (turned off) the arc turns off, with a regular electrical control circuit.

In contrast, with the torch trigger circuit for the “Self-Holding Function,” once the torch switch is pulled in (turned on), the arcing continues even if the welder releases the torch switch. This function is useful to release the welder from fatigue of holding the torch switch during welding for a long welding line. For termination of the weld bead, the welder has to pull the torch switch in for crater treatment, “Crater Filler Function,” followed by releasing the torch switch to cut the arc. The crater filling current and voltage (60-70% of the welding current and voltage) can be initially set on the control panel of the power source.

Note:

According to the initial settings of welding current (wire feed speed) and arc voltage, the GMAW equipment provides automatic self-regulation of the electrical characteristics for a stable arc. Therefore, manual controls required for semiautomatic operation are torch position, travel speed, and travel direction. Of the torch positions, the nozzle-to-work distance (See **Figs. 2-11 and 2-12**) is very important because it affects the performance of the arc. An excessively long distance causes an unstable arc, much spatter generation, irregular bead appearance, less weld penetration, and lack of shielding, thereby causing porosity. In contrast, an excessively short distance causes an unstable arc, too.

Fig. 2-11 Nozzle-to-work distance and other definitions for the torch positions
(Source: AWS Welding Handbook)

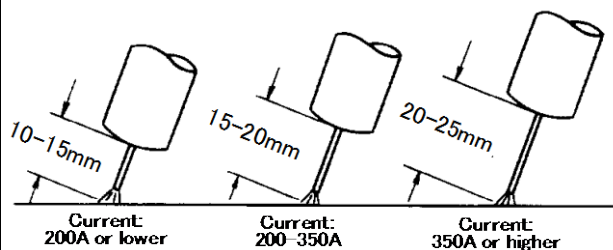
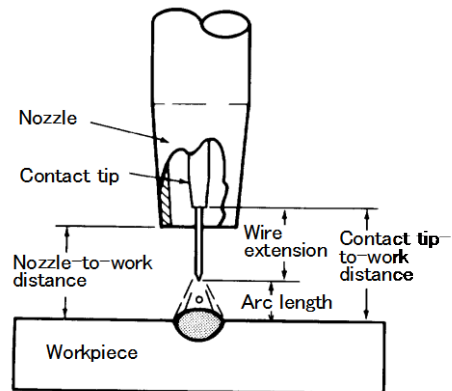

Fig. 2-12 Proper nozzle-to-work distance depends on welding currents.

11. Close the welding operation	<p>(a) Close the main cock of the shield gas cylinder, discharge the shielding gas remained in the gas passage between the gas regulator and the welding torch by operating the gas check switch. After confirming the gas regulator indicates the zero pressure, return the gas check switch to "Welding."</p> <p>(b) Turn off the main switch of the power source.</p> <p>(c) Turn off the main switch of the power line switchboard.</p>
---------------------------------	---

3. Essential Factors in GSMAW

3.1 Power sources and accessories

3.1.1 Power source varieties and basic characteristics

Gas shielded metal arc welding (GSMAW) uses direct currents with electrode positive (DCEP) for most applications. This is because the DCEP connection provides stable melting rates of welding wire and enables to use the advantages of several droplet transfer modes, by choosing the size of wire, levels of current and voltage, and type of shielding gas.

The major types of DC power sources can be categorized into engine-driven generators (rotating) and the transformer-rectifiers (static) with variations of inverter type, thyristor type, tap-switching transformer type, and slider-switching transformer type. The engine-driven generator is used at e.g., remote locations where no other source of electrical energy is available. **Table 3-1** shows the operational features of the static power sources.

Table 3-1 Operational features of GSMAW power sources

Type of power source	Operational features
1. Inverter type	<p>(a) The commercial-frequency AC of 50-60 Hz is rectified to DC, which is then switched (inverted) to high-frequency AC of 3-20 kHz by using an inverter; then the high-frequency AC is applied into a stepdown transformer to produce the desired welding voltage, which is again rectified to DC, followed by the waveform smoothing via a DC reactor for obtaining the output suitable for welding.</p> <p>(b) High-speed, precise control of current waveform enables to improve performance with stabilized welding current and arc voltage, reduced spatter generation, and quicker arc starting. These features are useful particularly in robotic and automated welding.</p> <p>(c) No input-side transformer is required, and voltage stepdown transformer and DC reactor can be compact due to high-frequency AC circuits. Therefore, the inverter type power source is characterized by reduced bulk and mass (half the thyristor type), better portability, less space taking, higher power factor, lower input power loss, and thus better electric power savings.</p> <p>(d) A-V automatic control can be done by a remote controller.</p>
2. Thyristor type	<p>(a) Thyristor is used to rectify the transformed AC voltage, and DC reactor is used to output DC currents with smoothed waveform.</p> <p>(b) Welding current and arc voltage can be finely adjusted continuously by the knobs of the remote controller.</p> <p>(c) Many brands use only the A-V individual control, but some can also facilitate the A-V automatic control by shifting the switch.</p> <p>(d) Many models for high welding currents facilitate the crater treatment control.</p> <p>(e) With relatively simple structure and no movable part, durability is excellent, and therefore this type has been used widely.</p>
3. Tap-switching or slider-switching transformer type	<p>(a) Output voltage can be adjusted by controlling the tap/slider contact on the transformer.</p> <p>(b) Welding current can be adjusted by the adjusting knob/lever of the A-V individual/automatic control.</p> <p>(c) Fine adjustment and remote control of output cannot be done.</p>

With constant-voltage GSMAW power sources, when all other variables are held constant, the welding current varies with the wire feed speed or melting rate in a nonlinear relation. As the wire feed speed is varied, the welding amperage will vary in a like manner. This relationship of welding current with the wire feed speed for carbon steel wire is shown in **Fig. 3-1**. The curves can be affected by several factors such as types of wire, shielding gas, and wire extension.

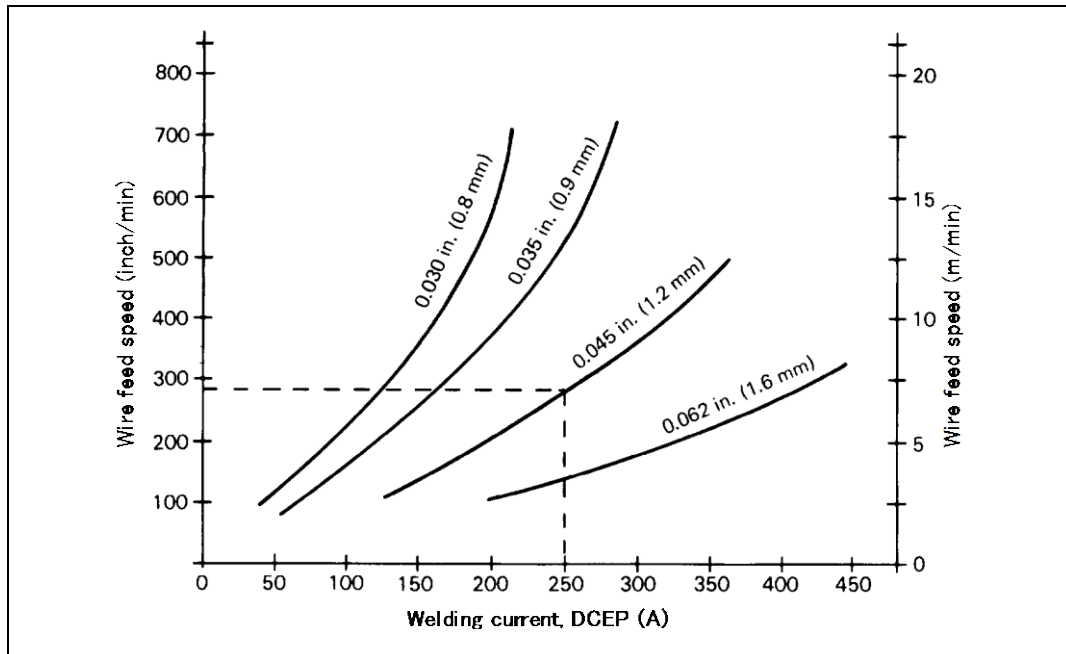

Fig. 3-1 Typical welding currents vs. wire feed speeds for carbon steel electrode (Source: AWS Welding Handbook)

3.1.2 Duty cycle and permissible currents

The use of a power source in the conditions that exceed the rated duty cycle can cause burn of the power source because of overheating the power source components. Power sources are designed, in an economical point of view, to use under the conditions of intermittent loads where the arc is often turned on and off as seen in usual welding operations. In other words, power sources including their accessories are designed thermally safe, provided they are used within specified rated duty cycles. As shown in **Fig. 3-2**, duty cycle can be defined as a ratio, as a percentage, of the load-on (generating an arc) time to a specified time of cycle in welding operation.

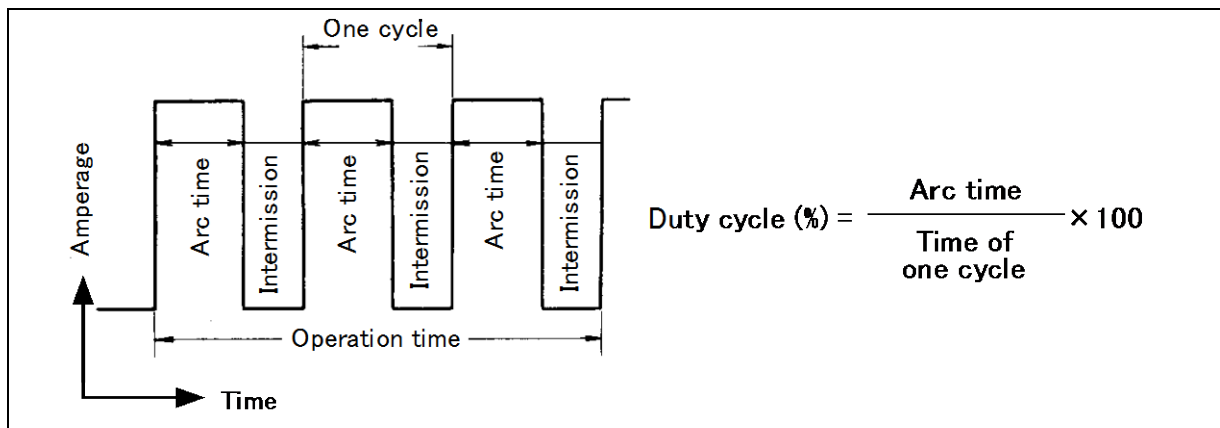

Fig. 3-2 A definition of duty cycle

For testing a power source as per the JIS C 9300-1:2006 (Arc Welding Equipment-Part 1: Arc Welding Power Sources), similar to IEC 60974-1:2005 (IEC: International Electrotechnical Commission), duty cycle is based on a test interval of 10 minutes. Therefore, a power source rated at 60% duty cycle can be loaded, in one cycle of operation, for 6 minutes at its rated current followed by intermission for 4 minutes. This means that this power source cannot be loaded continuously at the “rated current” for 36 minutes out of 60 minutes, because the duty cycle in this case does not constitute 60% but 100%. This should be noted, particularly, in use of an automated welding process that tends to be load-on continuously for a long time without interruption.

Duty cycle is a major factor in determining the type of service for which a power source is designed. The rated duty cycle of GMAW power sources of constant voltage output is specified by the power source manufactures; e.g., 30%, 40%, 50%, 60%, 80%, and 100%. Power source manufacturers perform duty-cycle tests under what the pertinent standard defines as usual service conditions. Factors that cause lower than the tested or calculated performance include high ambient temperatures, insufficient cooling-air quantity, and low line voltage.

Rated duty cycle (T_r), rated current (I_r), permissible duty cycle (T), and permissible current (I) have the following relationship: $T_r \times I_r^2 = T \times I^2$. Based on this relationship, the following formulas are given for estimating the duty cycle at other than rated output (3-1), and for estimating other than rated output current at a specified duty cycle (3-2).

$$T = \left(\frac{I_r}{I}\right)^2 \times T_r \quad \text{————— (3-1)}$$

Example 1: What duty cycle does the use of 300A output make in use of a power source rated at 60% duty cycle at rated current of 350A? Using equation (3-1): $T = (350/300)^2 \times 60\% = \text{approx. } 82\%$. Therefore, this unit can be loaded approximately 8 minutes out of each 10-minute period at 300A.

$$I = I_r \times \sqrt{\frac{T_r}{T}} \quad \text{————— (3-2)}$$

Example 2: The above-mentioned power source is to be loaded continuously, thus at 100% duty cycle. What output current must not be exceeded? Using equation (3-2):

$I = 350 \times \sqrt{(60/100)} = \text{approx. } 270\text{A}$. Therefore, if operated continuously, the current should be limited to 270A.

The aforementioned equations imply that welding currents exceeding a rated current could be used if the duty cycle is lower than the rated. However, welding currents should not be higher than the rated even if the duty cycle can be decreased. This is because thermal capacity of rectifier elements used in power sources is lower than that of the main transformer; thus, the use of currents higher than the rated can overheat the rectifier elements.

Furthermore, as defined as $H = I^2R \times T$ (where H: Joule heat, I: current, R: internal resistance, and T: duty cycle), the Joule heat generated in a power source is affected by the internal resistance of the power source, in addition to by current and duty cycle. This suggests that the joints between the components must sufficiently be fastened through maintenance activities to minimize the electrical resistance; if not, a loose joint can cause more heat than the estimated, which may cause overheating of the power source even if the duty cycle and welding current is within the specified.

In order to prevent overheating, duty cycle is specified for welding torches, too, in the same way as for power sources as discussed above. However, unlike power sources, the rated duty cycle of welding torches varies depending on how to use the welding torch: e.g. 80% for CO₂ welding, 60% for MAG welding, and 50% for pulse-MAG welding in use of the same welding

torch. This is because radiant heat from the arc to the tip of the torch varies affected by the welding process. The radiant heat becomes higher in CO₂ welding, MAG welding, and pulsed-MAG welding in this order, when other welding parameters are kept constant. Specifications of welding torches indicate the rated duty cycle when used in CO₂ welding, unless otherwise specified.

3.1.3 Welding cables and voltage drop

GSMAW welding power sources are designed so that they perform best when the welding cable having a specified diameter is extended 5-10m long in general. Therefore, the use of a longer cable or smaller cable causes deterioration of the welding performance. As shown in **Table 3-2**, the use of a longer cable, Case 2, results in worse welding performance when compared with the standard condition, Case 1, due to a significant voltage drop. In order to overcome this problem, the Case 3 increases the output terminal voltage so much as to compensate the voltage drop at the arc. Alternatively, the use of a larger size cable compensating the voltage drop (Refer to **Fig. 3-3**) by decreasing the electrical resistance of the cable will result in good welding performance. Such a wrong use of the cable that turns the cable round and round as shown in Case 4 in the table increases inductance of the cable, thereby causing an unstable arc. This tendency is increased when the rounded cable is put on a steel plate because of a larger inductance of the cable. This is why a long welding cable should be extended in parallel when it is used.

Table 3-2 Effects of welding cable placements on GSMAW performance

Condition of cable	Case 1: Standard	Case 2: Long cable	Case 3: Long cable with increased voltage	Case 4: Long rounded cable
Length of cable	5m	30m	30m	30m
Placement of cable				
Welding current	150A	150A	150A	150A
Output terminal voltage	20.5V	20.5V	23V	23V
Arc voltage	20.0V	Unstable	20.5V	20.0V
Short circuiting	80-100 times/sec	Unstable	60-80 times/sec	30-50 times/sec
Bead appearance	Good	Bad	Good	Bad
Arc start	Good	Bad	Good	Bad
Arc sound	Regular	Irregular	Regular	Irregular
Arc light	Stable	Unstable	Stable	Unstable

Fig. 3-3 Effect of cable sizes on arc voltage drop as a function of welding current



3.2 Welding wires

GSMW of mild steel and high strength steel commonly uses solid wires and flux-cored wires. Solid wires are used mainly in steel structures, autos, motorcycles, containers, rolling stock, and construction machinery. This is particularly because solid wires generate little slag and, thus, are more suitable for automated multiple-pass welding. In contrast, flux-cored wires are used mainly in bridges, ships, and offshore structures. This is especially because flux-cored wires offer very low spatter, smoother bead appearance and higher deposition rates. These wires are available in several package forms such as spools for general uses and pail packs for automated processes.

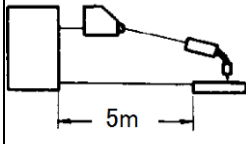
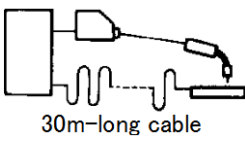
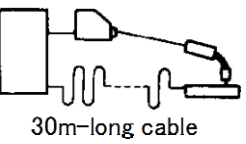
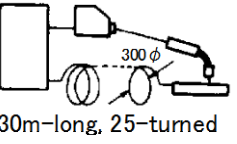
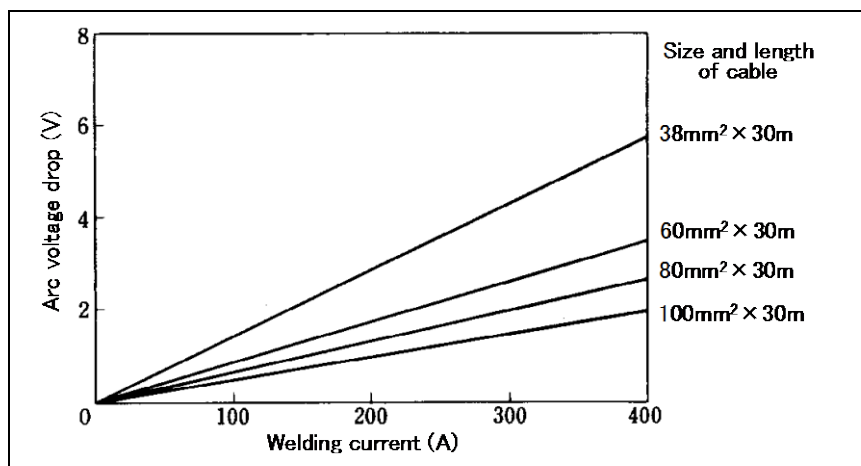
3.2.1 Types of solid wires

Some types of solid wires are designed to be more suitable for CO₂ gas shielding, while some other types are designed to be more suitable for 75-80%Ar/bal.CO₂ mixture gas shielding in GSMW. This is because the yield of wire chemical elements into the deposited metal is affected markedly by the shielding gas composition, as shown in **Fig. 3-4**, because of the chemical reaction between the molten metal and the shielding gas at high temperatures. That is, the oxygen produced by decomposition of CO₂ (e.g. CO₂ → CO + O) oxidizes silicon, manganese and other alloying elements supplied from the wire into the molten metal, producing oxides such as SiO₂ and MnO, which are separated from the molten metal by slagging. The yield ratio of chemical elements directly affects the mechanical properties of the deposited metal. Therefore, it is important to select a suitable wire, taking into account the type of shielding gas to be used.

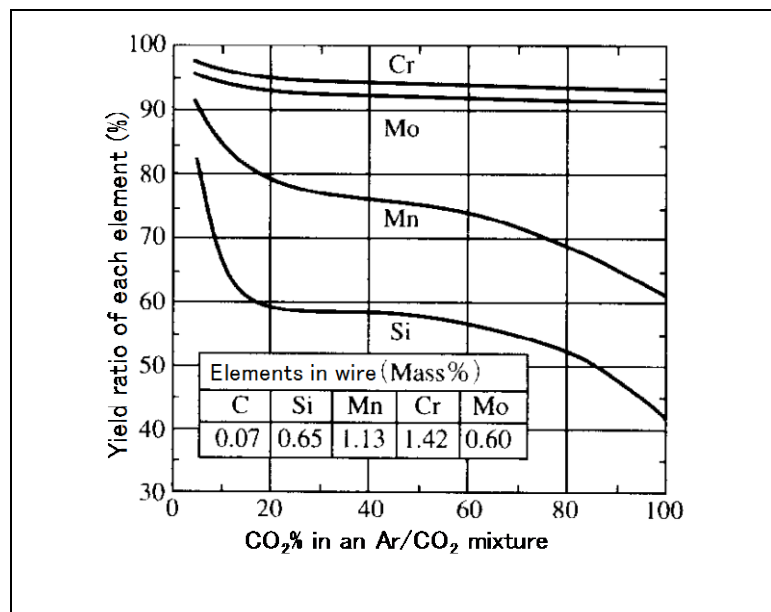

Fig. 3-4 Yield ratios of chemical elements as a function of CO₂% in an Ar/CO₂ mixture

Some types of wires are suitable for high welding currents, while some other types are suitable for low welding currents. This is because some brands of wires are designed suitable for sheet metals used in, for example, autos and motorcycles, and some other brands of wires suit for thick metals used in, for example, steel structures and pressure vessels. Sheet metals use low currents to prevent excessive melt-through (burn through), while thick metals use high currents to provide good penetration and high welding efficiency. The choice of high or low currents also depends on the welding position and the type of shielding gas associated with the metal transfer mode.

The use of high currents with a proper wire and CO₂ shielding gas provides a “globular arc” when the current and voltage are appropriate, which results in deep penetration and high welding efficiency in flat and horizontal fillet welding, though much spatter generates. The use of high currents with a proper wire and 75-80%Ar/bal.CO₂ shielding gas provides a “spray arc” when the current and voltage are correctly adjusted, which results in deep penetration and high welding efficiency in flat and horizontal fillet welding with low spatter generation. In contrast, the use of low currents with a proper wire and either a CO₂ or Ar/CO₂ shielding gas provides a “short-circuiting arc” when the current and arc voltage are appropriate, which results in low spatter generation and shallow penetration in all position welding. The three arc modes (globular, spray, and short-circuiting arcs) are detailed in the article 3.3.1.

Table 3-3 shows typical solid wires for general uses, specified by the JIS standard and AWS standard for welding mild steels, high strength steels, and low temperature steels. For detail characteristics such as chemical composition and mechanical properties, refer to

- JIS Z 3312:2009 (Solid Wires for MAG and MIG Welding of Mild Steel, High Strength Steel and Low Temperature Service Steel)
- AWS A5.18:2005 (Carbon Steel Electrodes and Rods for Gas Shielded Arc Welding)
- AWS A5.28:2005 (Low-Alloy Steel Electrodes and Rods for Gas Shielded Arc Welding)

Table 3-3 Typical solid wires for various applications

Application				Classification ⁽¹⁾	
Type of steel	Shielding gas	Welding position	Suitable mode of arc ⁽²⁾	JIS standard	AWS Standard (Kobe Steel brand ⁽³⁾)
Mild steel and 490N/mm ² -class high strength steel	CO ₂	Flat, Horizontal	More suitable for globular arc with high currents.	Z 3312 YGW11	A5.18 ER70S-G ([F] MG-50)
		All positions	More suitable for short-circuiting arc with low currents.	Z 3312 YGW12	A5.18 ER70S-6 ([F] MG-51T)
	75-80%Ar + bal.CO ₂	All positions	More suitable for spray arc with high currents.	Z 3312 YGW15	A5.18 ER70S-G ([F] MIX-50S)
		All positions	More suitable for short-circuiting arc with low currents.	—	A5.18 ER70S-3 ([F] MIX-50)
590N/mm ² -class high strength steel	CO ₂	Flat, Horizontal	Suitable for both short-circuiting and globular arcs in use of a wide range of currents.	Z 3312 G59JA1UC 3M1T	A5.28 ER80S-G ([T] MG-60)
	75-95%Ar + bal.CO ₂	All positions	Suitable for both short-circuiting and spray arcs in use of a wide range of currents.	Z 3312 G59JA1UM C1M1T	A5.28 ER90S-G ([T] MG-S63B)
400-490N/mm ² -class high strength steel for low temperature	75-80%Ar + bal.CO ₂	All positions	Suitable for both short-circuiting and spray arcs in use of a wide range of currents.	Z 3312 G49AP6M 17	A5.18 ER70S-G ([T] MG-S50LT)

Note:

(1) The cross references between JIS and AWS classifications are based on available brands supplied by Kobe Steel.

(2) The suitable arc modes are based on available brands supplied by Kobe Steel.

(3) [F]: FAMILIARCTM, [T]: TRUSTARCTM

3.2.2 Types of flux-cored wires

Flux-cored wires (FCWs) can be classified into three types: rutile type, basic type, and metal type. FCWs consist of a steel sheath and a cored flux that contains various chemical ingredients such as deoxidizer, arc stabilizer, slag former and metal powder (alloying element and iron powder) to obtain desired chemical and mechanical properties of the deposited metal, usability, and welding efficiency. Rutile-type FCWs contain rutile-based flux. Basic-type FCWs contain lime-fluoride-based flux. Both types of FCWs generate sufficient amounts of slag to cover the entire part of the weld bead. Rutile-type FCWs offer excellent usability, while basic-type FCWs offer superior crack resistance. In contrast, the major flux ingredient of the metal-type FCW is metal powder that becomes part of the deposited metal, causing little slag covering. **Table 3-4** shows a qualitative comparison between the rutile, basic and metal type on welding performance, including that of solid wires for reference.

Table 3-4 A comparison between different types of FCWs and solid wire on welding performances ⁽¹⁾

Performance	Solid wire	Rutile- and basic-type FCW	Metal-type FCW
Deposition rate	High	Higher (See Fig. 3-5)	Highest (See Fig. 3-5)
Deposition efficiency	Higher (e.g. 95%)	High (e.g. 88%)	Higher (e.g. 95%)
Key points of Usability	<ul style="list-style-type: none"> • Little slag (Multi-pass welding without removing slag is possible.) • Spatter depends on welding parameters. 	<ul style="list-style-type: none"> • Little spatter • Smoother bead appearance 	<ul style="list-style-type: none"> • Little slag (Multi-pass welding without removing slag is possible.) • Little spatter
Suitability for all-position welding	Depends on welding parameters and brands.	All positions (Some brands are for flat and horizontal fillet only.)	Flat and horizontal fillet (Some brands are for all positions.)

Note:

(1) The performance of a welding wire differs by brand; therefore, this table should be used as a rule of thumb.

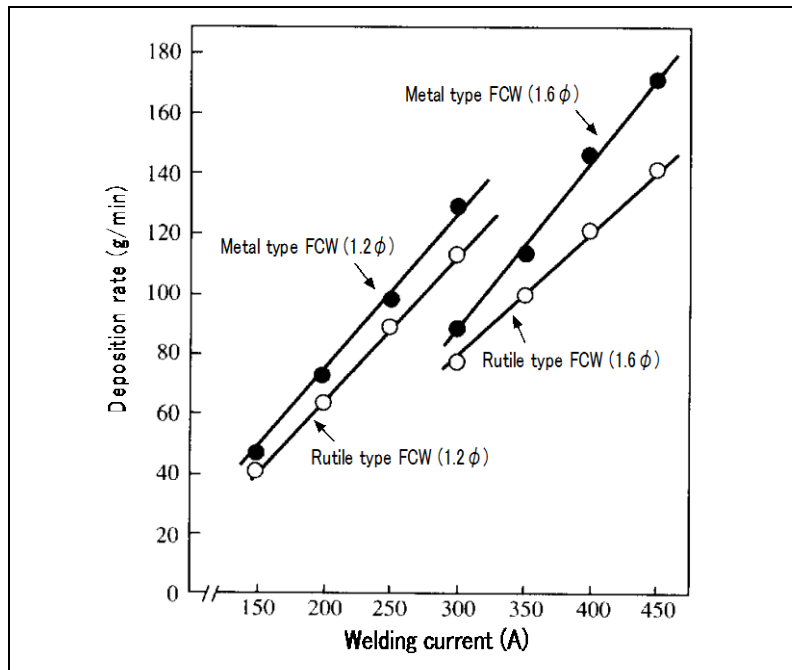

Fig. 3-5 A comparison between rutile- and metal-type FCWs on deposition rate in CO₂ GSAW (wire extension: 25mm)

Table 3-5 shows typical FCWs for general uses, specified by the JIS standard and AWS standard for welding mild steels, high strength steels, and low temperature steels. For detail characteristics such as chemical composition and mechanical properties, refer to

- JIS Z 3313:2009 (Flux Cored Wires for Gas Shielded and Self-Shielded Metal Arc Welding of Mild Steel, High Strength Steel and Low Temperature Service Steel)
- AWS A 5.20:2005 (Carbon Steel Electrodes for Flux Cored Arc Welding)
- AWS A5.29:2010 (Low-Alloy Steel Electrodes for Flux Cored Arc Welding)

Table 3-5 Typical flux-cored wires for various applications

Application				Classification ⁽¹⁾	
Type of steel	Shielding gas	Welding position	Type of flux ⁽²⁾	JIS standard	AWS Standard (Kobe Steel brand ⁽³⁾)
Mild steel and 490N/mm ² -class high strength steel	CO ₂	All positions	Rutile type	Z 3313 T49J0T1-1CA-U	A5.20 E71T-1C ([F] DW-100)
			Metal cored ⁽⁴⁾	Z 3313 T49J0T15-1CA-U	A5.18 E70C-6C ([F] MX-100T)
		Flat, Horizontal fillet	Rutile type	Z 3313 T49J0T1-0CA-U	A5.20 E70T-1C ([F] DW-200)
			Metal type	Z 3313 T49J0T1-0CA-U	A5.20 E70T-1C ([F] MX-200)
	75-80%Ar + bal.CO ₂	All positions	Basic type	—	A5.20 E71T-5M-J ([F] DW-A51B)
			Metal cored ⁽⁴⁾	Z 3313 T49J0T15-1CA-U	A5.18 E70C-6M ([F] MX-100T)
Flat, Horizontal fillet		Metal type	—	A5.20 E70T-1M ([F] MX-A200)	
610N/mm ² -class high strength steel for low temperature	CO ₂	All positions	Rutile type	—	A5.29 E91T1-Ni2C-J ([T] DW-62L)

Note:

- (1) The cross references between JIS and AWS classifications are based on available brands supplied by Kobe Steel.
- (2) The types of fluxes are based on available brands supplied by Kobe Steel.
- (3) [F]: FAMILIARCTM, [T]: TRUSTARCTM
- (4) Metal cored wire is specified in AWS A5.18:2005, different from metal-type flux-cored wire as per A5.20:2005.

3.3 Welding Practice

In GMAW, the quality of welds is markedly affected by various welding factors that determine the arc characteristics, molten pool's motion, and gas shielding effect. This section discusses how to control such factors in welding practices.

3.3.1 Droplet transfer modes and applications

How molten metals are transferred in an arc, from the electrode tip to the molten pool, determines the suitability for a particular welding position, amount of spatter, and quality of weld. Based on the studies by high-speed photography of the gas shielded metal arc welding process, the manners of molten metal transfer can be classified loosely into “globular transfer,” “spray transfer,” and “short-circuiting transfer.” Both globular and spray transfers are also known as “free flight transfer,” because the molten metals transfer while flying in the arc. Short-circuiting transfer, however, is very different because the molten metals bridge the tip of the electrode and the molten pool in excess of 50 times per second during welding. **Figure 3-6** shows a schematic comparison between these three types of droplet transfer. Of these drawings, the globular and spray transfer modes show typical transfer profiles; however, the short-circuiting transfer mode shows just one step of the mode. **Figure 3-7** details the entire steps of the short-circuiting mode.

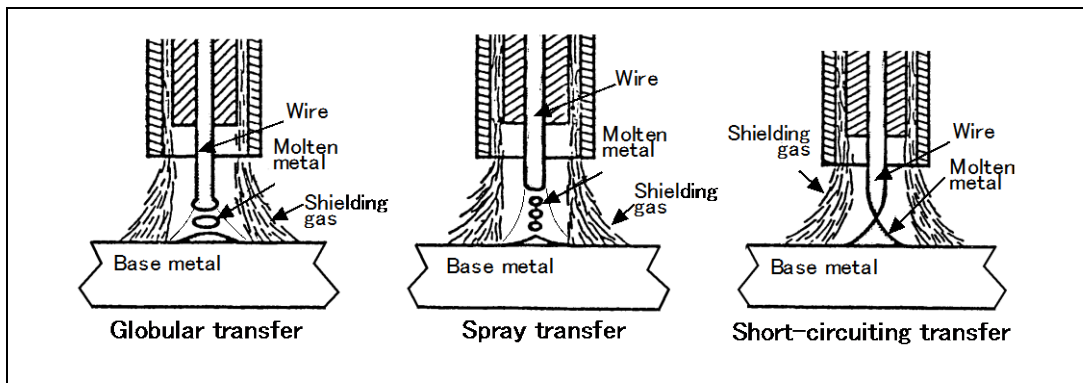

Fig. 3-6 Three major droplet transfer modes in GMAW

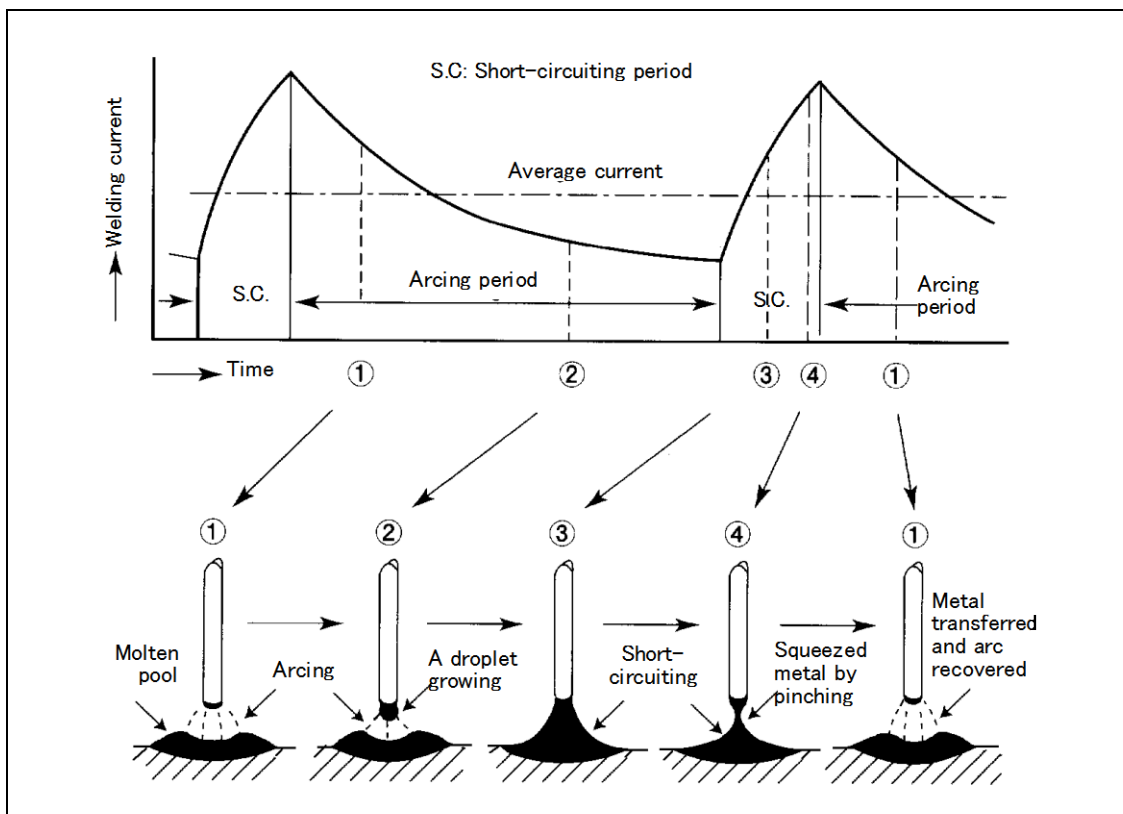

Fig. 3-7 — The mechanism of typical short-circuiting droplet transfer associated with welding current output

These three droplet transfer modes are determined by such welding parameters as welding current, arc voltage, and type of shielding gas when the size and kind of wire and the type of power source are kept constant. **Figure 3-8** shows how welding current and shielding gas composition determine the droplet transfer mode and spatter generation rates, when other welding parameters are kept constant. As shown in the figure, globular transfer mode can occur at higher currents with CO₂-rich shielding gases. With Ar-rich shielding gases, however, the use of high currents causes spray transfer mode. In contrast, short-circuiting transfer mode can occur at lower currents with a wide range of shielding gas compositions.

Looking upon the amount of spatter, the use of a low current decreases spatter due to the mechanism of short circuiting transfer, whereas the use of a high current causes a large amount of spatter in globular transfer with CO₂-rich shielding gases. However, in the spray transfer with Ar-rich shielding gases at high currents, the amount of spatter markedly decreases to the extent lower than in the short-circuiting transfer.

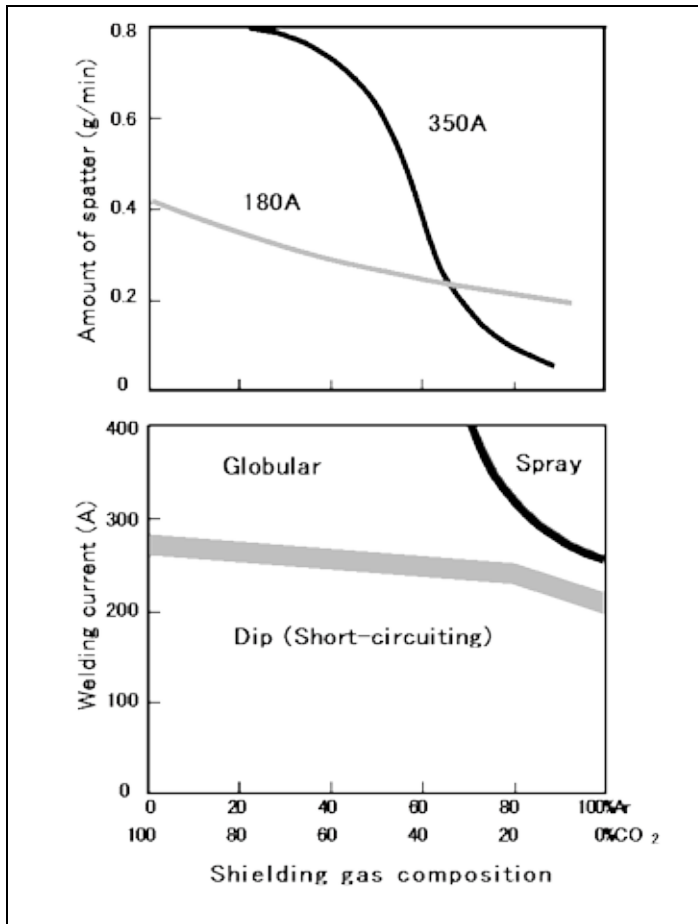

Fig. 3-8 Droplet transfer modes and the amount of spatter in conventional GMAW using a solid wire
(Source: AWS Welding Journal)

The frequency of short-circuiting determines the characteristics of the short-circuiting transfer, which is affected by arc voltage. **Figure 3-9** shows how the frequency of short-circuiting is affected by arc voltage. At the largest number of short-circuiting, the amount of spatter becomes least with a stable arc.

Fig. 3-9 — The frequency of short-circuiting as a function of arc voltage in the use of a solid wire of 1.2mm ϕ at a current of approximately 150A

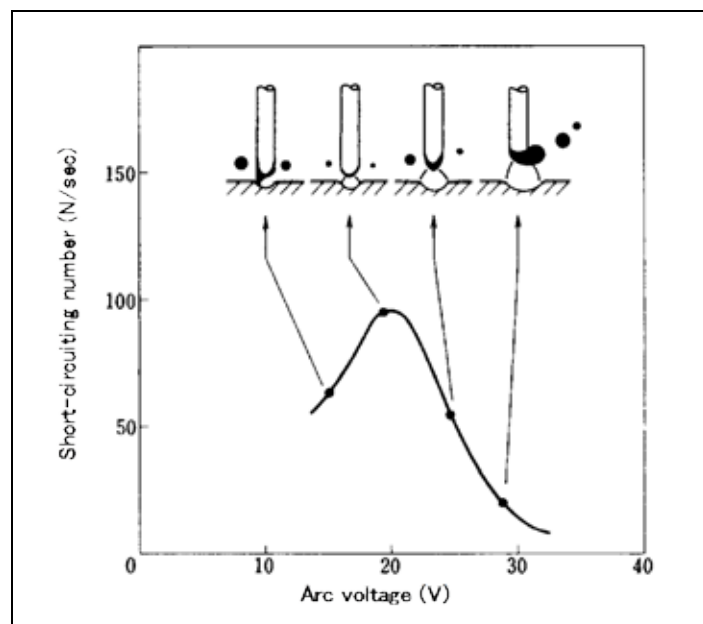

Figure 3-10 shows a general guidance to proper ranges of welding currents and arc voltages in the cases of globular and short-circuiting arcs; more fine adjustment may be needed for an exact solid wire to be used.

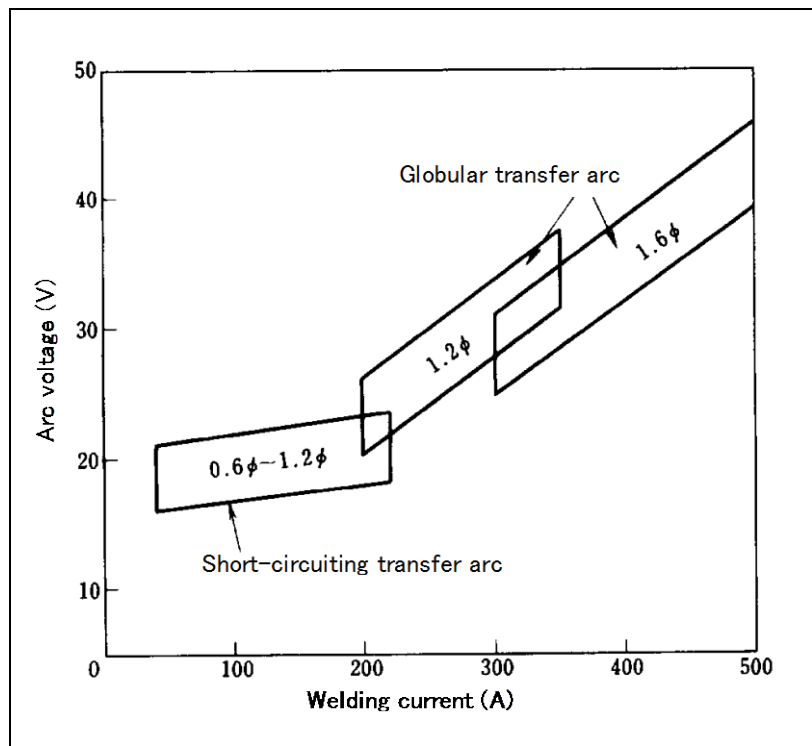

Fig. 3-10 — A general guidance to proper ranges of welding current and arc voltage for globular and short-circuiting transfer arcs with solid wires of 0.6, 1.2, and 1.6mm ϕ

The high arc energy associated with the globular transfer arc is not suitable for joining sheet metals due to excessive melt-through (burn-through) or for welding the work in the vertical or overhead positions because of the extrusion of molten metals. This type of arc, therefore, is used extensively for flat and horizontal fillet position welding of thick steels, expecting deep penetration and high welding efficiency, though the amount of spatter is larger.

In contrast, the low arc energy associated with the short-circuiting arc is suitable for joining sheet metals in all-position welding, featuring low spatter, shallow penetration, and less undercut.

Like the globular arc, the spray arc is inherently suitable for welding thick materials in flat and horizontal fillet welding due to its high arc energy, featuring, unlike the globular arc, very low spatter. The work thickness and welding position limitations for the spray transfer arc have been largely overcome with specially designed power sources. These power sources produce controlled waveforms and frequencies that pulse the welding currents. As shown in **Fig. 3-11**, during this pulse, one or more drops are formed and projected, by the arc pinch effect, across the arc to the molten pool. By reducing the average welding current and applying pulsed high currents, the pulsing makes the desirable features of spray transfer available both for joining sheet metals and for welding thick metals in all positions. The pulsed arc produces deeper penetration and better root fusion than does a short-circuiting arc.

Table 3-6 summarizes the applications for globular, spray, and short-circuiting arcs, and outlines the individual features.

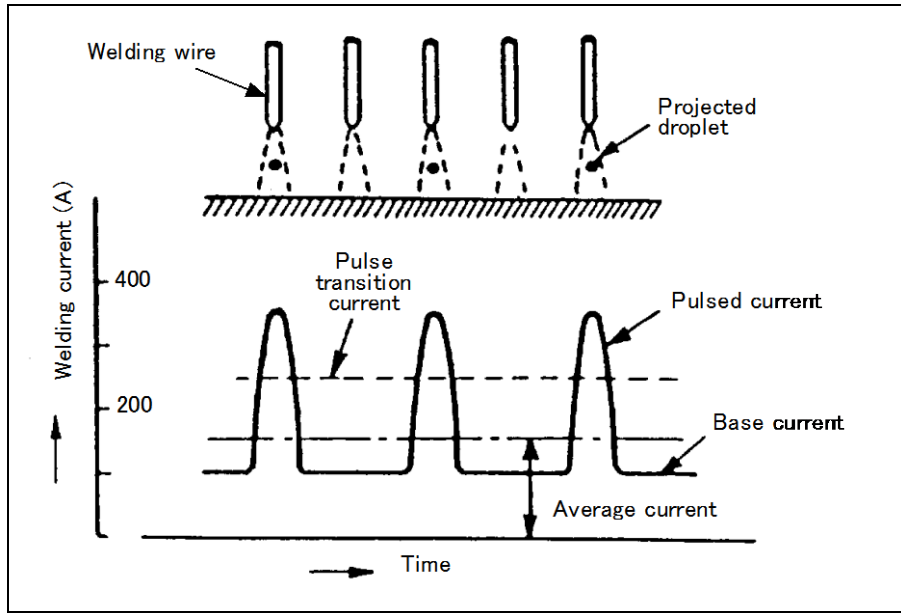

Fig. 3-11 Typical pulsed-arc metal transfer (For solid wires)

Table 3-6 — A summary of applications for each droplet transfer mode (For solid wires)

Droplet transfer mode	Feature	Application	
		Plate thickness	Welding position
Globular	Deep penetration, Much spatter	Med. and thick work	Flat and horizontal fillet
Spray	Deep penetration, Little spatter	Med. and thick work	Flat and horizontal fillet
Short-circuiting	Shallow penetration, Little spatter	Thin work	All positions
Pulsed	Middle penetration, Little spatter	Thin and thick work	All positions

Most of flux-cored wires are designed to use high currents in globular droplet transfer. However, unlike solid wires, the globular arc with a flux-cored wire generates very low spatter with a very stable arc due to the effect of its cored flux. In addition, the molten slag of an all-position type flux-cored wire can prevent the molten metal from dropping down, thereby producing a flat weld bead with very smooth surfaces even in vertical up, vertical-down and overhead positions. Therefore, as shown in Fig. 3-12 for an example, high welding currents can be used in any welding position, thereby facilitating high welding efficiency. Some brands (e.g. FAMILIARC™ MX-100T), however, are designed to use low currents with short-circuiting transfer mode for sheet metals in all positions.

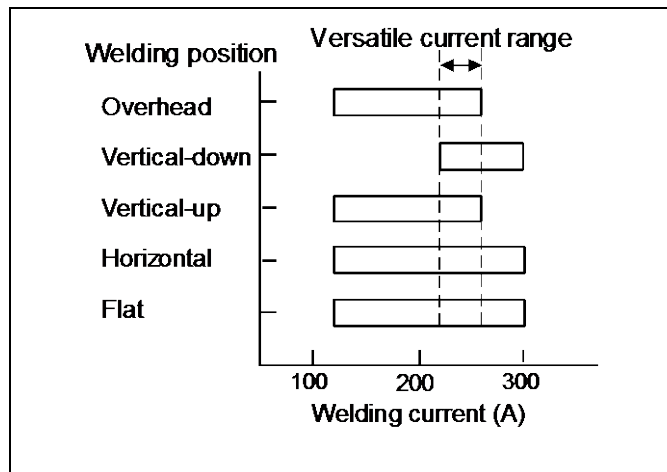

Fig. 3-12 Proper welding current ranges and a versatile current range for all-position welding in use of an E71T-1M type flux-cored wire of 1.2mm ϕ

3.3.2 Welding parameters and weld quality

Weld bead profiles can be varied by such welding parameters as welding current, arc voltage, and welding speed. The weld profiles include bead width, reinforcement size, penetration, and bead appearance. **Table 3-7** shows how the combination of welding current and arc voltage affects the weld profiles, when the welding speed is kept constant.

Table 3-8 shows the effect of welding speed on the weld profiles, when welding current and arc voltage are constant. **Figure 3-13** compares a normal bead and a humping bead containing undercut caused by an excessively fast welding speed.

Table 3-7 Effects of current and voltage on weld profiles (Solid wires, CO₂ shield, 9-mm T mild steel)

Arc voltage (V)	Welding current (A)			
	150	200	250	300
35				
33				
31				
29				
27				
25				
23				
21				
19				
17				

Table 3-8 Effect of welding speeds on weld profiles
 (Solid wire, welding current: 200A, Arc voltage: 21V, 9-mm T mild steel)

Welding speed (cm/min)	Weld profile
25	
50	
75	
100	

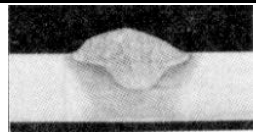
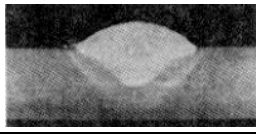
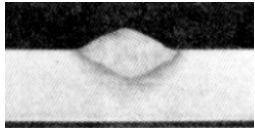
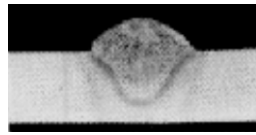
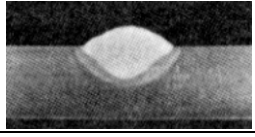
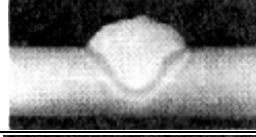
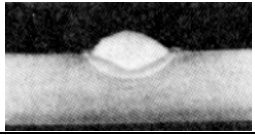
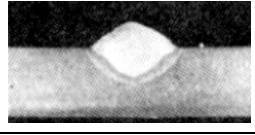
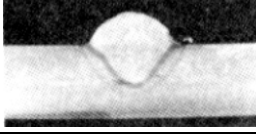
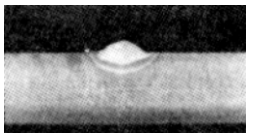
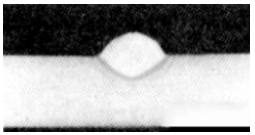
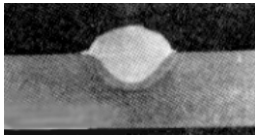
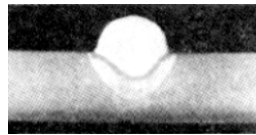
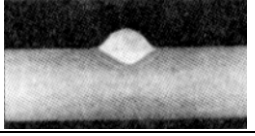
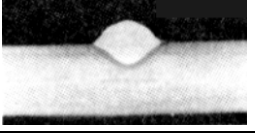
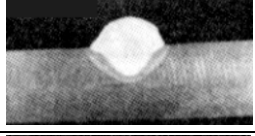
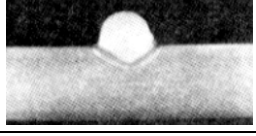
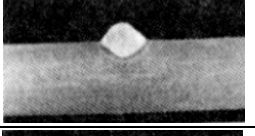
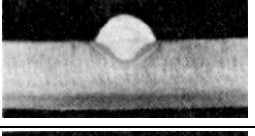
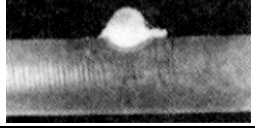
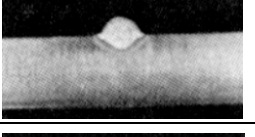
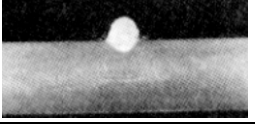
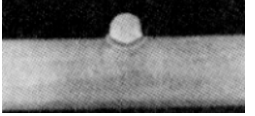
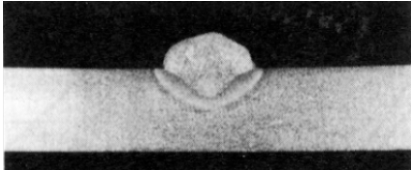
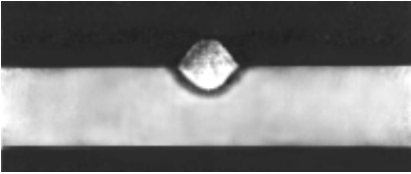
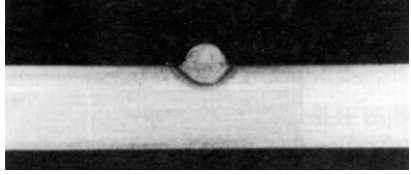
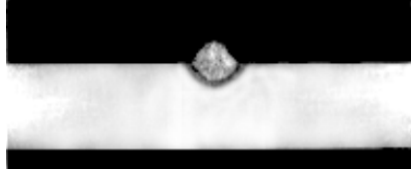
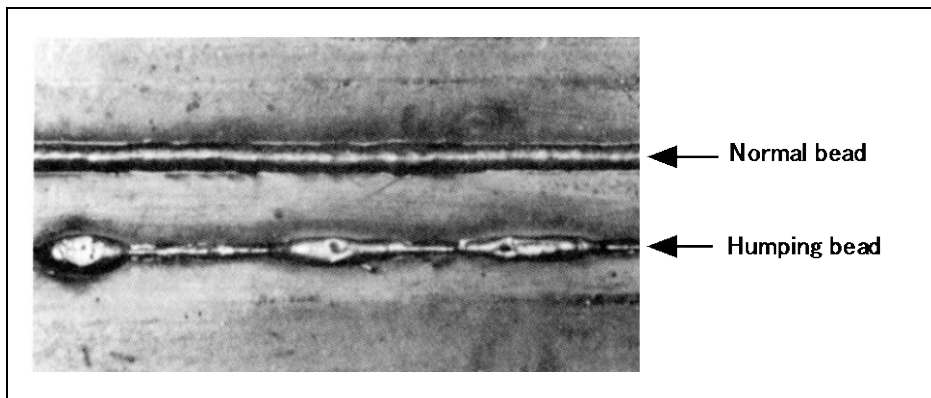
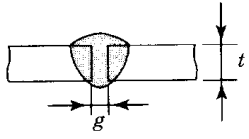
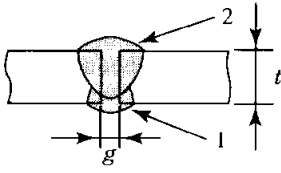

Fig. 3-13 A typical humping bead caused by an excessively fast welding speed (100cm/min or higher) in use of a solid wire

In addition, the size of wire is another important welding parameter. **Table 3-9** shows a general guidance to suitable sizes of wire for thin and med-thick steel materials in relation to other factors such as welding current, arc voltage, welding speed, and root opening. In welding sheet metals, excessive melt-through (burn-through) is one of the serious problems. **Figure 3-14** shows critical conditions to prevent burn-through as functions of welding current, welding speed, and type of wire (solid wire vs. metal core wire). This figure suggests that the use of lower currents and higher welding speeds can prevent burn-through and the metal core wire (FAMILIARC™ MX-100T) has a wider range of welding conditions that can prevent burn-through.

Table 3-9 Proper welding conditions for square joints in use of solid wires

Plate thickness: t (mm)	Size of wire (mm)	Root opening: g (mm)	Welding current (A)	Arc voltage (V)	Welding speed (cm/min)	Pass sequence
1.2	0.8, 0.9	0	70-80	18-19	45-55	
1.6	0.8, 1.0	0	80-100	18-19	45-55	
2.0	0.8, 1.0	0-0.5	100-110	19-20	50-55	
2.3	1.0, 1.2	0.5-1.0	110-130	19-20	50-55	
3.2	1.0, 1.2	1.0-1.2	130-150	19-21	40-50	
4.5	1.2	1.2-1.5	150-170	21-23	40-50	
6.0	1.2	1.2-1.5	220-260	24-26	40-50	
9.0	1.2	1.2-1.5	320-340	32-34	40-50	

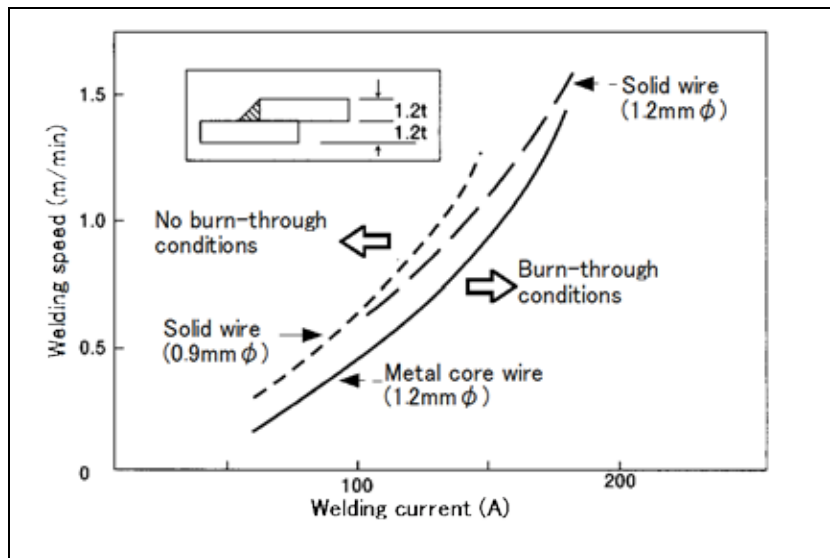

Fig. 3-14 Critical conditions of causing burn through in use of a solid wire (ER70S-6) and metal cored wire (E70C-6C) in welding sheet metal lap joints

In relation to welding current and arc voltage, the wire extension affects the quality of GSMAW welds. The wire extension, as shown in Fig. 2-11, is the distance between the tip of the contact tube and the tip of the wire. With a usual GSMAW power source (a constant-voltage output with constant-speed wire feeding), the self-correction mechanism of the power source control the arc length almost constant by compensating sudden fluctuation in the arc length. However, an increase in the wire extension finally results in an increase in the arc voltage and arc length to a certain extent (depending on the V-A output characteristics), which in turn causes an unstable arc with increased spatter. In contrast, a decrease in the wire extension finally results in a decrease in the arc voltage and arc length, which in turn causes an unstable arc with increased spatter. Therefore, the wire extension must be kept to be an appropriate size depending on the size of wire and the welding current, as shown in **Table 3-10**.

A wrong operation for the arc starting with a long wire extension can cause “burn-back.” The burn-back is an arc outage in which wire feed is interrupted, causing the filler wire and contact tip to melt together due to the sparks between them. This condition stops the wire from feeding through the contact tip and stops the welding operation, damaging the contact tip as shown in Fig. 3-15.

Table 3-10 Typical wire extensions in relation to wire sizes and welding currents

Wire size (mm)	Welding current (A)	Wire extension (mm)
0.6, 0.8	100 max	10 max
0.9, 1.2	100-200	10-15
1.2, 1.4	200-350	15-20
1.6, 2.0	350 min	20-25

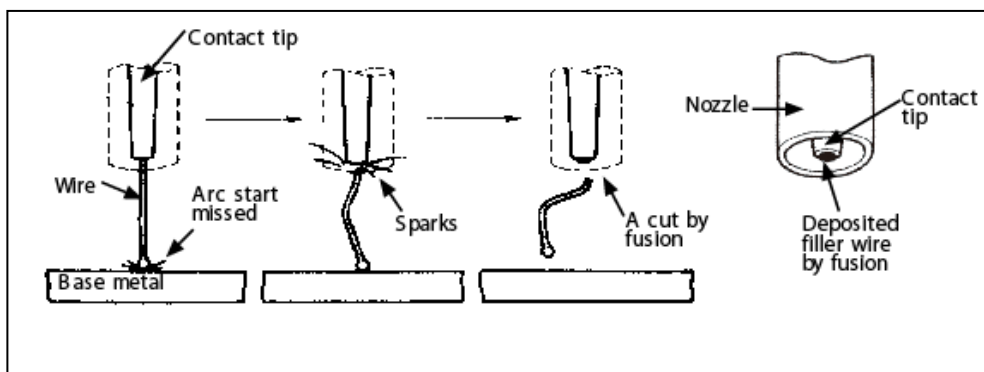

Fig. 3-15 A process of burn-back in GMAW

3.3.3 How to ensure the shielding effect

In gas shielded metal arc welding (GMAW), the quality of weld metal can be affected by the shielding effect. Lack of shielding can cause an unstable arc, air-contaminated weld metal, and porosity. One of the main factors that affect the shielding effect is wind. **Figure 3-16** shows the effect of wind velocity on the amount of blowholes in GMAW using different types of shielding gases and wires. This figure suggests that the permissible wind velocity is 2 m/sec, though the flux-cored wire has better resistance than the solid wire. Therefore, when GMAW has to be carried out in a windy area wherein the wind velocity is over the permissible velocity, the welding area must be shielded with a screen to protect the arc and molten pool from the adverse effects of wind.

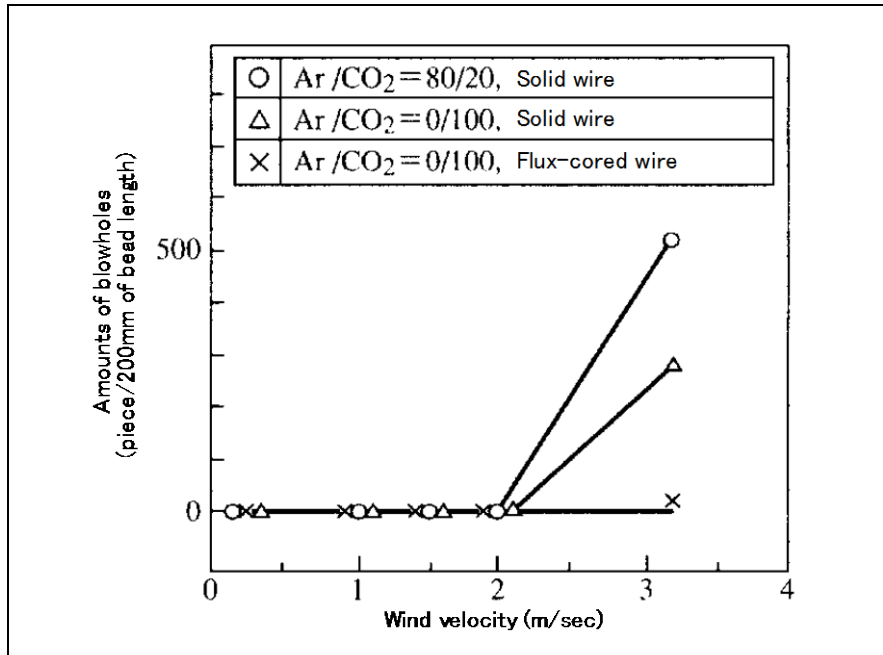

Fig. 3-16 Effects of wind on amounts of blowholes in GMAW
 (Wire size: 1.2mm ϕ , Welding current: 300A, Shielding gas flow rate: 25)

The shielding effect can also be affected by other factors such as shielding gas flow rate, nozzle-to-work distance, and arc voltage. Even if the flow rate of a shielding gas is sufficient, the use of a nozzle in which much spatter deposits as shown in **Fig. 3-17** can cause lack of shielding because the flow of shielding gas is disturbed and the effective shielding area decreases. No use of a gas orifice or the use of a damaged gas orifice as in **Fig. 3-18** disturbs a regular stream of shielding gas, thereby causing lack of shielding.

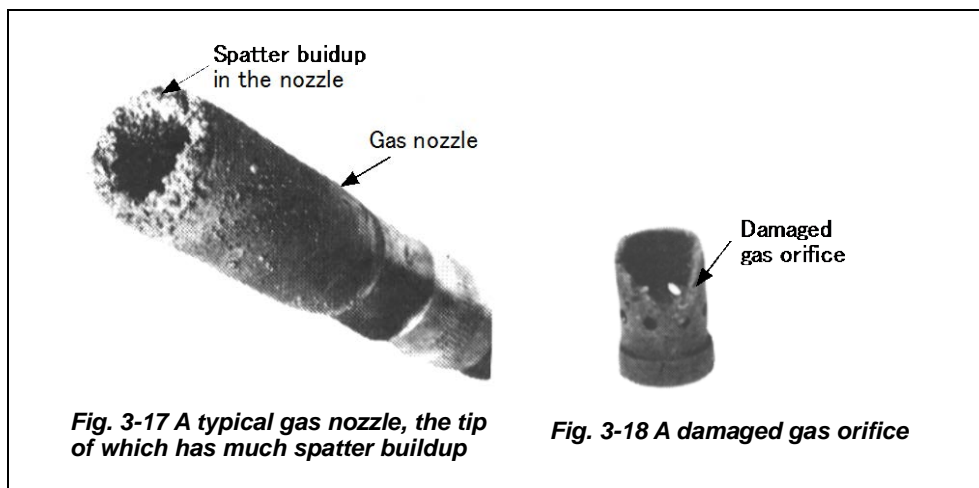

Fig. 3-17 A typical gas nozzle, the tip of which has much spatter buildup

Fig. 3-18 A damaged gas orifice

In addition, a loose connection and tear in the gas passage can leak pressurized shielding gases, thereby causing lack of shielding even when the gas regulator indicates the correct pressure and the gas flow meter shows the correct flow rate. In order to prevent this trouble routine maintenance is important.

3.3.4 How to ensure good wire feeds and stable arcs

Electrode wire must be fed smoothly to ensure good arc stability. For this, buckling or kinking of the wire must be prevented by maintaining the wire passage in the correct condition. Particularly, the conduit liner material and inner diameter are important. Conduit liners require periodic maintenance to assure they are clean and in good condition for consistent feeding of the wire. As previously mentioned, care must be taken not to crimp or excessively bend the conduit.

In gas shielded metal arc welding, the electrode wire is fed at quite high speeds from few to ten-odd meters per minute, being kept contact at the tip of the contact tube that conveys welding currents. Therefore, the contact between the wire and the contact tip must be kept in good condition to keep persistently a stable arc. The contact must not be too tight or loose. With excessively tight contact, copper flakes are prone to clog the contact tip, causing irregular wire feeding. In contrast, loose contact makes the electricity conduction unstable, thereby causing an unstable arc. Therefore, the use of the proper size contact tip matching the wire to be used is an essential practice and, when the contact tip is worn out after a long time operation, it must be replaced with a new one. **Figure 3-19** compares between a suitable contact tip and a loose one on arc stability in short-circuiting arcs. This test result shows obviously that the use of a loose contact tip causes a fluctuation in short-circuiting frequency, thereby causing irregular bead appearance.

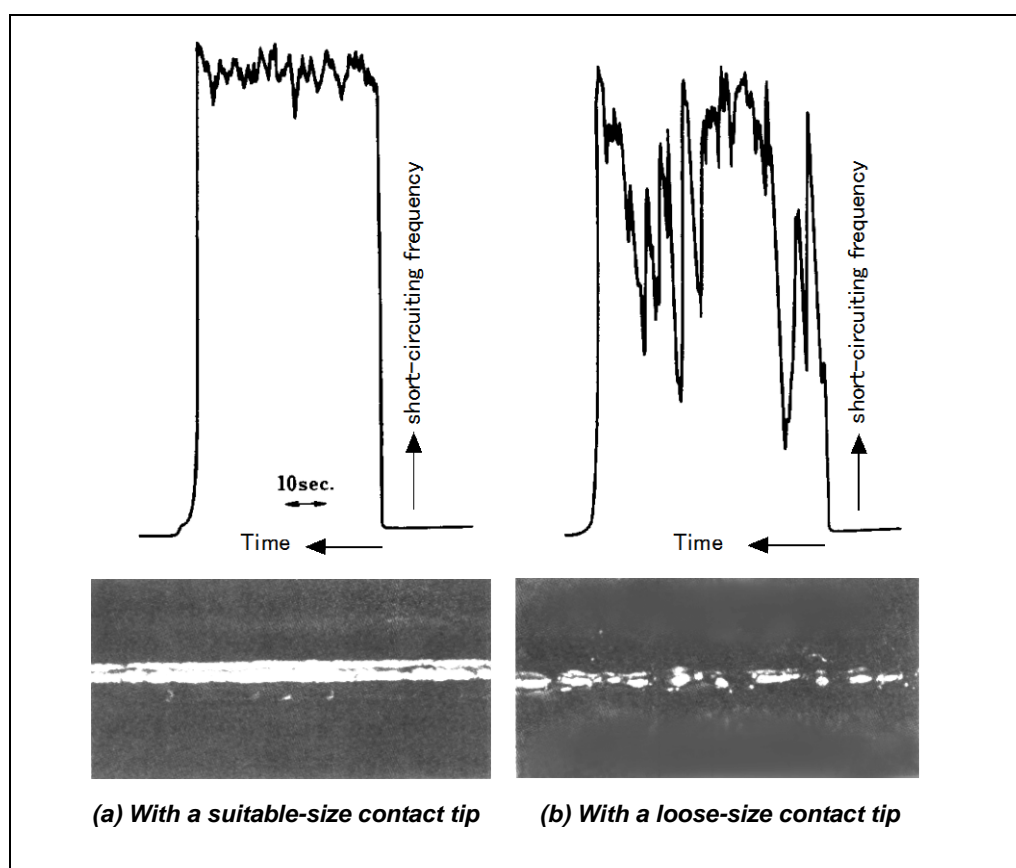

Fig. 3-19 A comparison of arc stability exhibited by short-circuiting frequency and bead appearance with suitable-size and loose-size contact tips

Spatter deposition in the contact tip may cause irregular wire feeding and an unstable arc. Loose fixing of the contact tip in the joint, as shown in **Fig. 3-20**, causes deterioration in electrical conductivity and an unstable arc. Overheating the joint can burn the screws.

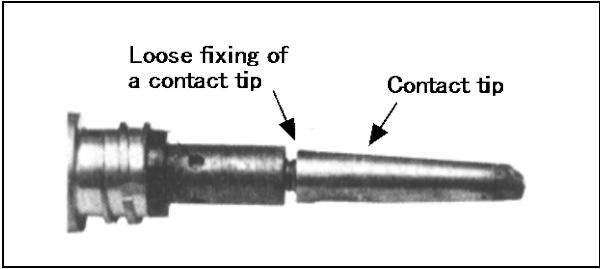

Fig. 3-20 Loose fixing of a contact tip can cause an unstable arc and burn in the joint

The conduit liner used for a long time may deposit, on its inner surfaces, grease, steel powders, dust, and copper flakes carried in by the welding wire. Such deposits deteriorate the wire feeding. The conduit liner, therefore, should be taken out from the conduit cable (Refer to **Fig. 3-21**) to check the appearance and clean it once a week in general. In checking the appearance of a conduit liner, be sure to check an excessive bend and crimp such as those shown in **Fig. 3-22**. Such damages cause irregular wire feeding and thus an unstable arc.

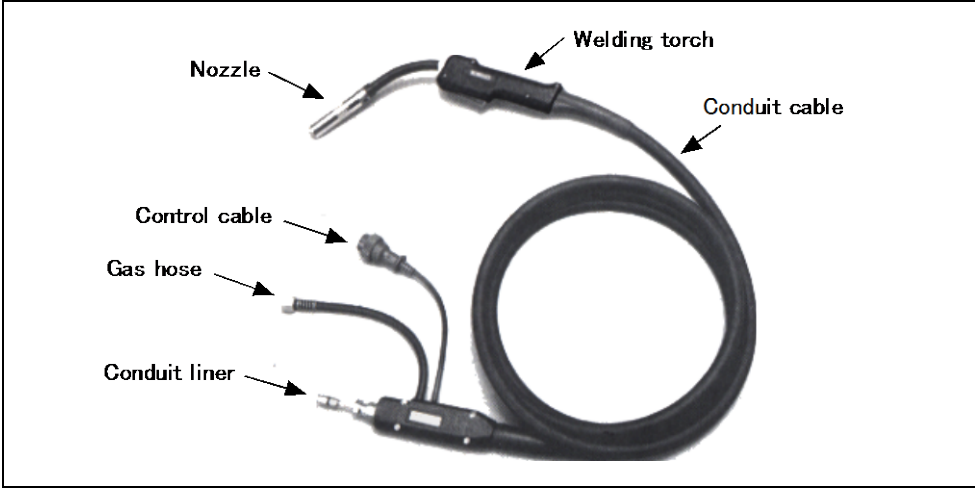

Fig. 3-21 A conduit liner should be taken out periodically from the conduit cable, and check its appearance to ensure good wire feedability

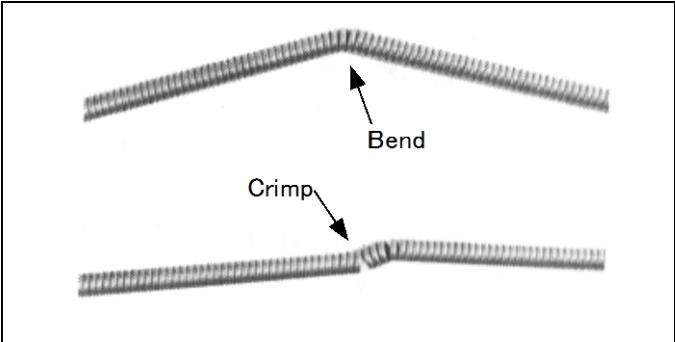

Fig. 3-22 A bend and crimp cause irregular wire feeding and an unstable arc

3.3.5 Electrode orientations and applications

The orientation of the welding electrode wire with respect to the weld joint affects the weld bead shape and penetration. The electrode orientation can be described in two ways: (1) the relationship of the electrode axis with respect to the direction of travel (travel angle: drag angle and push angle) and (2) the angle between the electrode axis and the adjacent work surface (work angle), as shown in **Fig. 3-23**.

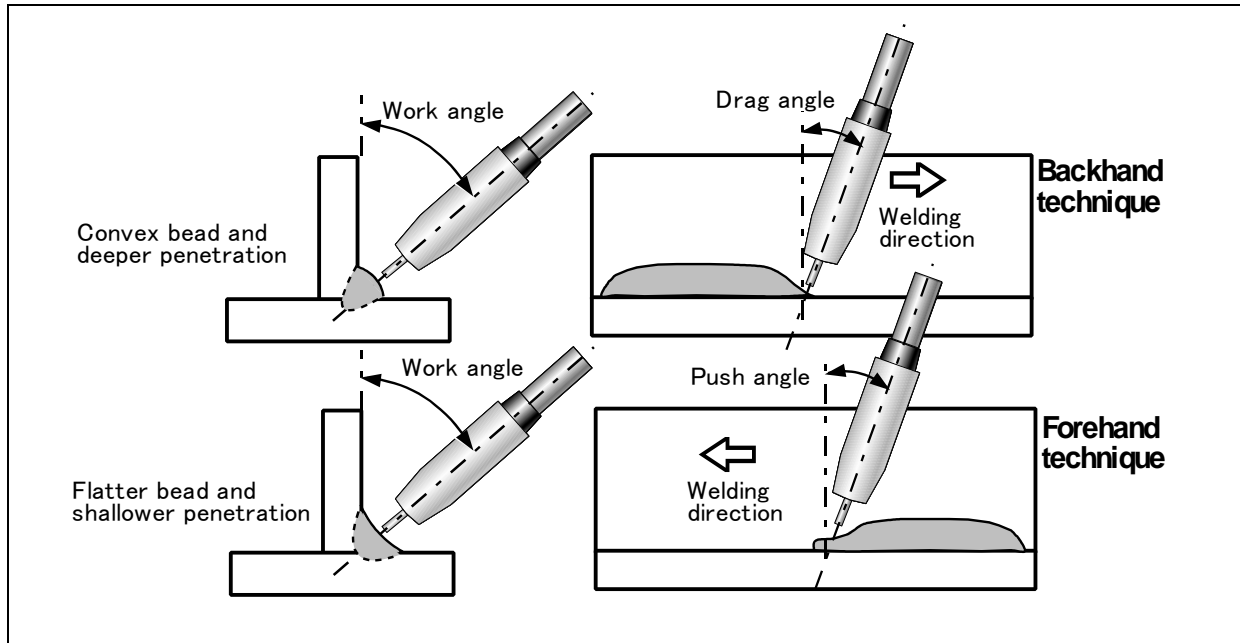

Fig. 3-23 Definitions of work angle, drag angle, and push angle

In the “backhand” welding technique, the wire is pointed with a drag angle (10-20 degrees) towards the opposite of the travel direction. When the wire is pointed with a push angle (10-20 degrees) towards the travel direction, this manner is called the “forehand” welding technique. Each technique has advantages and disadvantages as summarized below, provided all other conditions are kept unchanged. **Table 3-11** shows typical applications for each technique.

Backhand technique

- (1) The welder’s view to the welding line is obstructed by the torch nozzle, thus the control of wire tracking is not easy.
- (2) The weld bead becomes narrower and thicker.
- (3) Spatter tends to be captured by the molten pool, thus less spatter deposits on the workpiece.
- (4) The weld penetration increases because the arc can expose to the base metal more efficiently.

Forehand technique

- (1) The welder can control the wire tracking along the welding line more easily because he/she can easily see the welding line.
- (2) The weld bead becomes wider and flatter.
- (3) The arc force directed forward projects larger size spatter.
- (4) The weld penetration becomes shallower because the molten pool buffs the arc force directed to the base metal.

Table 3-11 Applications for backhand and forehand techniques

Application		Backhand technique	Forehand technique
Flat	Sheet metals	Not suitable because the deeper penetration tends to cause burn-through.	<u>Suitable</u> due to shallower penetration and flatter beads.
	Medium and thick plates	<u>Suitable</u> for the root and filling passes because of deeper penetration and better fusion.	<u>Suitable</u> for the cover pass due to shallower penetration and flatter beads.
Horizontal fillet	Single pass	Not suitable because the narrower, thicker bead tends to be a convex bead.	<u>Suitable</u> due to flatter beads and less undercut.
	Multiple passes	<u>Suitable</u> for the root and filling passes due to deeper penetration and thicker beads.	<u>Suitable</u> for the cover pass due to flatter beads and less undercut.
Vertical up	Any	Not suitable due to extruded beads.	<u>Suitable</u> due to flatter beads.
Vertical down	Any	<u>Suitable</u> due to flatter beads.	Not suitable due to concave beads.
Overhead	Any	— (Note)	— (Note)

Note:

A recommended orientation of the wire is almost perpendicular to the work as shown in the figure right. A short-circuiting arc is recommended due to low spatter and flat beads in use of either solid wires or flux-cored wires.

