

Characteristics of New Pre-painted Steel Sheet for Automotive Industry

Takashi SAITO; Sheet Products Marketing & Technical Service Department, Iron & Steel Sector
 Masatoshi IWAI; Research and Development Laboratory, Kakogawa Works, Iron and Steel Sector

There is a growing demand for corrosion protection in automotive hems and flanges without using additional materials, such as waxes and sealers. Kobe Steel developed, in the past, zinc-rich primer painted galvanized steel sheets. In order to improve weldability and to lower the production cost, a new pre-painted steel sheet has been developed. The new steel sheet is coated with epoxy resin containing FeP pigments (50mass%) with a maximum particle diameter of 12 microns on the galvanized layer. The new steel sheet exhibits excellent formability, an extended welding tip life and a higher corrosion resistance.

Introduction

To extend guarantee against perforation corrosion, several European automotive manufacturers have started using a highly corrosion resistant, zinc-rich type coating covering the electro-galvanized (EG) layer (70g/m² zinc) of EG steel sheets. The coating material can eliminate the need for both wax and sealer which otherwise are applied by auto manufacturers to guarantee corrosion resistance¹⁾. Kobe Steel has developed a new pre-painted steel sheet for automotive industry. The pre-painted sheet, which is based on galvanized steel sheet widely used by Japanese auto-manufactures, is featured by improved weldability and low production cost compared with steel with the zinc-rich type coating. The following describes the characteristics of the weldable, pre-painted steel sheet for automobiles.

1. Experimental procedure

1.1 Samples

A galvanized (GA) steel sheet of 0.8 mm thickness was used as the base material. The coating mass of galvanized layer was 45 g/m² and Fe content was 10%.

1.2 Paint composition

Table 1 shows the composition of the paint applied on the GA steel sheets. Base resin was an epoxy type and a melamine type resin was added as a curing agent. Various amount of FeP (Ferro Phosphorous) pigment was added to the paint as conductive filler.

1.3 Preparation of pre-painted steel sheet

Chromate-free primer was first applied to the GA steel sheets. A coating with a target thickness of 5 micron was then painted using a bar coater (#8) and was baked for 1 minute at 240°C (peak metal temperature) to prepare samples of the weldable pre-painted steel sheets.

1.4 Evaluations

Table 2 summarizes the evaluation methods. The tests include (1) the basic characterization of the painted steel, (2) formability, (3) spot-weldability and (4) corrosion resistance. Fig. 1 shows the details of the formability test. The corrosion resistance was evaluated by (a) a cyclic corrosion test (CCT) and b) a VDA test. Fig. 2 and Fig. 3 show the sample shape and the testing conditions for the VDA test, respectively.

Table 1 Composition of paint

Resin	Base : epoxy type	Curing agents : melamine type
Electric Conductive Pigments	Type	FeP
	Maximum diameter	12 μm, 16 μm
	Content	40% , 50%

Table 2 Methods of estimation

	Methods of estimation
Formability	Hat channel drawing with beads
Weldability	Electrode force ; 1.96KN Welding time ; 12cycles (60Hz) Cu-1%Cr tip diameter : 6 (mm)
Cyclic Corrosion Test (CCT)	JASO-M609
VDA test	Adhesive heating phosphate ED VDA

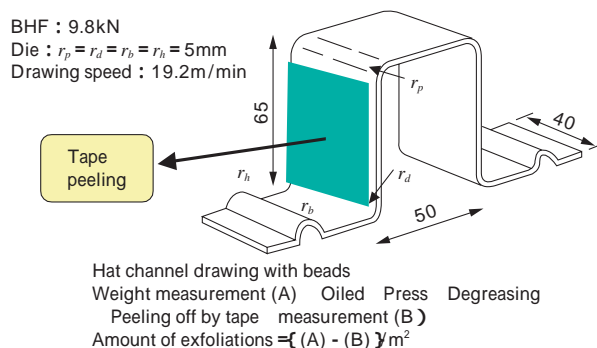

Fig. 1 Details in formability test

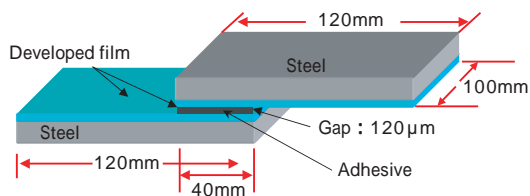

Fig. 2 Details of VDA test samples

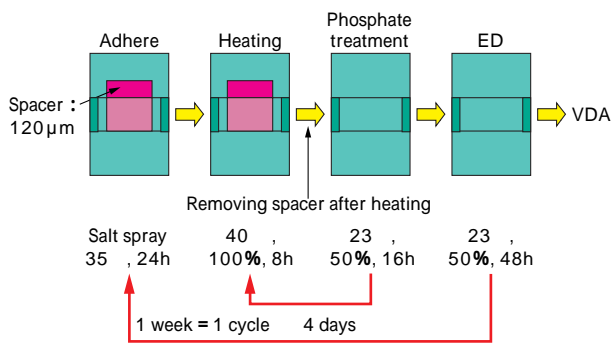

Fig. 3 Process of VDA test

2. Test results

2.1 Basic characteristics of pre-painted steel sheet

Table 3 summarizes the basic characteristics of a steel sheet coated with a paint containing 50% of FeP having 12 micron diameter. The steel sheet satisfies all the requirements of the pre-coated metal (PCM) for use with general electric appliances. The criteria for such requirements include no-crack limit of 3T after T bending test, pencil hardness of H, no crack resulted neither from Erichsen test nor Du Pont impact test, and no peeling of primary adhesion and the secondary adhesion caused by boiling water immersion.

2.2 Formability test results

Fig 4 shows the amount of coatings exfoliated during hat channel drawing tests with beads²⁾. The sample with FeP pigment of 16 microns exfoliated 3.5 g/m² of coatings, while the one with 12 micron FeP exfoliated 2.5 g/m², i.e., the smaller FeP diameter results in a less amount of particles released. SEM observations were conducted before and after the hat channel drawing tests to clarify the difference in coatings exfoliated. Photo 1 shows the resulting SEM micrograph.

The sample with larger (16 microns) FeP pigment shows a larger number of asperities before the drawing test. In the case where larger FeP pigment is used, the FeP pigments initiate cracks or scratches in the coating, causing the coating to flake off. This seems to have caused the larger amount of coatings exfoliated. For the reasons described above, the

Table 3 Characteristics of new pre-painted galvanized steel sheet

Test items	Test conditions and procedures	Properties
Bend test	Judgment of no crack limited	3T
Pencil hardness	Judgment of injured hardness by scratching the paint film under 1kg mass	H
Adhesion test	Tape peeling after 1 × 1mm cross-cut	No peeling
Erichsen test	7mm height by Erichsen tester	No crack
DuPont impact test	1/2in × 500g × 50cm	Prime side
		Back side
		No crack

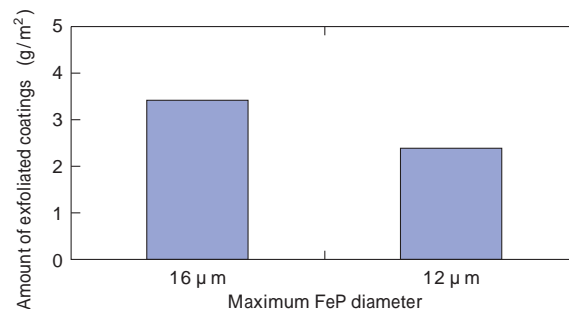

Fig. 4 Relationship between maximum FeP diameter and amount of exfoliated coatings

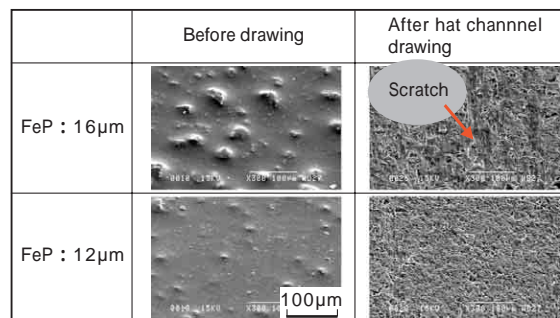

Photo 1 SEM images of paint surfaces before and after hat channel drawing with beads

particle diameter of FeP was selected to be 12 microns. The following experiments were all conducted on samples with FeP of 12 micron diameter.

2.3 Weldability

Fig. 5 shows the relation between FeP content and welding current range. Both the samples with 40% FeP and 50% FeP indicate about the same nugget formation currents, while the sample with 50% FeP exhibits a higher expulsion limit and also a higher electric sticking limit.

Based on the welding current ranges shown in Fig. 5, continuous spot-welding tests were conducted. A welding current was selected for each sample to be 1.4 times the current which makes the nugget diameter of 4.25 t (t: sheet thickness). Tensile shear tests were performed for every 100 spots welded. Fig. 6 includes the result for sheets with 40 % FeP and 50% FeP, as well as that for a comparable sheet with

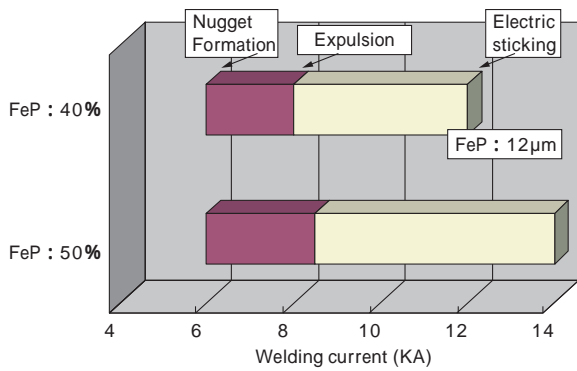

Fig. 5 Relationship between FeP content and welding current range

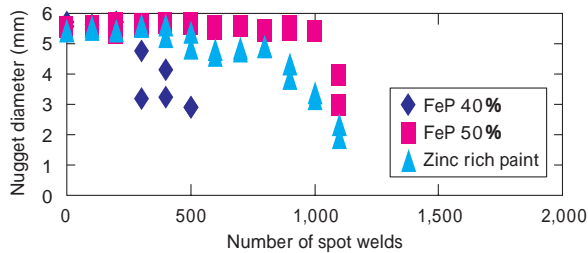

Fig. 6 Change of nugget diameter in continuous spot welding

zinc-rich paint.

In the case of 40% FeP, the nugget diameter became less than the standard value of $4.25 t$ after 300 to 400 spots. Nuggets with diameters larger than $4.25 t$ can be formed for the sheet coated with zinc-rich paint up to continuous spots of 800, however, the standard nugget diameter can not be achieved after 900 spots. The sheet with 50% FeP, on the other hand, exhibits a consistent nugget diameter up to 1000 or more of spots, exceeding the continuous spot welding performance of the zinc-rich painted sheet. Fig. 7 shows the tensile shear strengths measured at 100 spot intervals.

The zinc-rich painted sheet retains a constant tension-shear strength up to 500 continuous spots, however, the strength lowers significantly over 500 spots. The tension-shear strength of the sheet with 40% FeP coating decreased every one hundred spots. On the other hand, the tension-shear strength of the sheet with the 50% FeP coating demonstrates a consistently high tension-shear strength up to 1000 continuous spots, exhibiting a tension-shear strength exceeding that of the zinc-rich painted sheet.

Based on the above result, the optimal FeP content was determined to be 50%. An evaluation then was made on the positive effect of FeP on continuous spot-weldability. Photo 2 shows the cross sectional SEM micrograph of a paint film containing 50% FeP. The FeP particles, which are pulverized, are irregularly shaped with sharp edges and distributed uniformly in the paint film. The substance is also

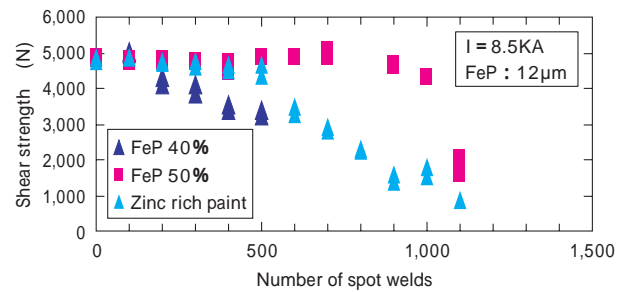

Fig. 7 Change of shear strength in continuous spot welding

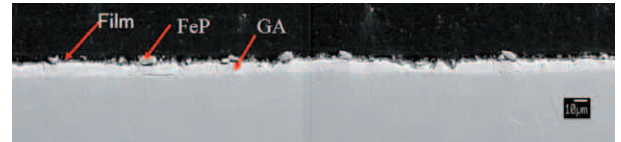

Photo 2 SEM photo of cross section of developed paint film containing 50% FeP

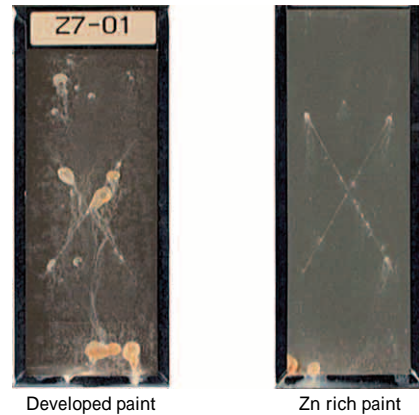

Photo 3 Appearances of samples after CCT-JASO90 cycles

featured by its melting point as high as 1320°C . When added to the paint film, the irregularly shaped particles should increase the number of electrical contacts with their sharp edges compared to the spherical Zn particles in zinc-rich paint. In addition, the high melting point of the particulates should suppress the reaction with the welding tip and reduce damage to the electrode tip. These factors are considered to have improved the continuous spot-weldability.

2.4 CCT-JASO corrosion test result

Photo 3 shows the appearance of a sample subjected to a cyclic corrosion test (CCT) according to JASO M609-91. All of the developed sheets and zinc-rich painted sheets show red rust after 90 cycles of CCT. The developed coating has a corrosion resistance almost equivalent to that of zinc-rich paint.

2.5 VDA test

Photo 4 shows the results after 20 cycle of the VDA

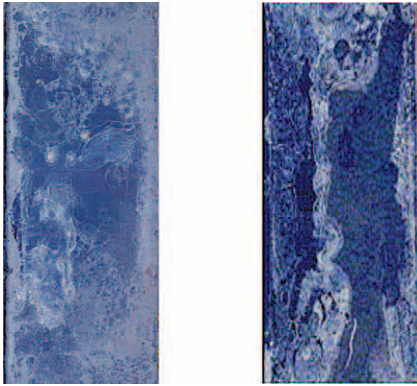

Developed paint

Zn rich paint

Photo 4 Appearances of glass flange test samples after VDA 20 cycles

test, which is a test method for joint portions. No sample exhibited any red rust, implying that the developed coating provides the same level of corrosion protection as the zinc-rich paint.

Conclusions

Based on galvanized (GA) steel sheets, a weldable coated steel sheet for automobiles was studied to

improve weldability and reduce coating cost compared to zinc-rich coated sheet. The results show that;

- 1) An epoxy resin base coating containing a melamine curing agent and 50% of FeP with a maximum diameter of 12 microns provides excellent formability and weldability, enabling continuous spot-welding up to 1000 spots, which exceeds the welding performance of zinc-rich painting;
- 2) JASO-CCT and VDA tests confirmed that the developed pre-painted steel sheet exhibits a corrosion resistance equivalent to that of zinc-rich paint; and
- 3) A weldable pre-painted steel sheet can be provided based on galvanized (GA) steel sheet.

Reference:

- 1) A. Schnell et al.: *Weldable Corrosion Protection Primers for the Automotive Industry, Galvatech'04(6th International Conference on Zinc and Zinc Alloy Coated Sheet Steels)*, April 4-7, (2004), pp.279-290.
- 2) H. Irie et al.: *R&D Kobe Steel Engineering Reports*, Vol.52, No.3 (2002), pp.35-38.