

# Nondestructive Measurement of Earing Using an Electro-Magnetic Acoustic Transducer

Toshihide FUKUI\*1, Yasuhiro WASA\*1, Kazutaka SHIGEOKA\*2

\*1 Production System Research Laboratory, Technical Development Group

\*2 SHINKO INSPECTION & SERVICE CO., LTD.

*A highly accurate acoustic velocity measurement system using an Electro-Magnetic Acoustic Transducer (EMAT) has been developed in order to evaluate the texture of aluminum plates. A good correlation between acoustic velocity anisotropy and earing is found for various kinds of aluminum plates, and earing can be estimated to be at 0.5% by measuring the anisotropy of the acoustic velocity. This system is applicable to inline inspection and all-length inspection, and can replace the conventional offline destructive measurement.*

## Introduction

Many common products such as drinking cans, food container lids, pots and pans and aluminum hubcaps are made of deep drawn aluminum sheets. Since these products are made by embossing (cup-molding) aluminum sheets several times, uniformity and isotropicity in plastic deformation of aluminum sheets, in addition to sheet thickness, become crucial. Generally, cup edges develop unevenness called "ears." Since "earing" represents the dimensional ratio of an ear, it has correlations with product yield and potential production line troubles during and after molding processes. Therefore, it is counted as one of the quality assurance items for deep drawing materials.

Since texture in the material is the cause of earing, Kobe Steel, as a material manufacturer, has been striving to improve the material quality by controlling texture in relation to rolling and heat treatment conditions. However, the quality assurance cannot be extended to all units or all lengths, since the texture control is performed by offline observation and analysis. This report describes a technology we developed for predicting post-process "earing" by measuring ultrasonic anisotropy at high precision through non-contact ultrasound aided by an electromagnetic acoustic transducer.

## 1. Cause of earing

Once shipped, aluminum sheets are processed into designated cup shapes, by going through molding processes such as punching, deep drawing using dies and punches and ironing/spatula ironing. Retightenable bottlecans that came into the market recently are a typical example. Fig. 1 shows the

simplest deep drawing processing of aluminum sheets and a commonly used standard measurement method for ears and earing. A circular sample was punched out of an aluminum sheet and was deep-drawn, to measure an uneven ear at the edge of the can. Its height was measured at 45 degree angle increments, with the direction of rolling being 0 degree, to define value of the earing ratio using equation (1).<sup>1)</sup>

$$\text{Earing} = \frac{(H_{45} - H_{0-90})}{(H_{45} + H_{0-90}) / 2} \times 100(\%) \dots\dots\dots(1)$$

In this equation,  $H_{0-90}$  represents average ear height of four directions including directions of rolling and width directions, and  $H_{45}$  represents average ear height of four directions in increments of 90-degree angles starting at 45 degrees away from the rolling direction. There are two types of ears, namely "negative ear," an ear protruding in the rolling direction (0 degree) or its orthogonal direction (90 degrees), and "positive ear," an ear protruding in 90-degree increments starting from 45 degrees away from the rolling direction. Conceptual drawings of these two ear types are shown in Fig. 2.

Cause of earing is known to be texture in an aluminum sheet<sup>2), 3)</sup>. While atoms and molecules are lined up in an orderly fashion with monocrystalline materials, thereby causing anisotropy, with polycrystalline materials, its anisotropies end up cancelling out each other making the material isotopic on a macro level. However, even polycrystalline metal sheets may develop texture

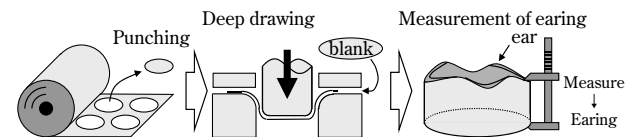

Fig. 1 Deep drawing and earing

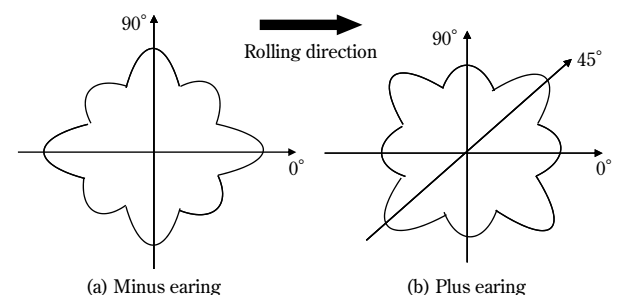

Fig. 2 Two types of earing shape images

from developing skewed crystal orientation through processing and heat treatment during manufacturing processes. This texture causes anisotropy during deformation processes such as deep drawing, resulting in development of ears. Correlations between sheet processing and texture are as the following<sup>4</sup>.

[Annealing texture] (100) <001>: Cube orientation, (110) <001>: Goss orientation, etc.

[Rolling texture] (123) <634>: S orientation, (112) <111>: C orientation, (110) <112>: Brass orientation, etc.

Since aluminum is a metal with a face-centered cubic structure, deformation proceeds along the slip system of slip surface (111)/slip direction <110> during plastic deformation. When a texture is deep drawn, anisotropy occurs in the direction of such an orientation. Correlation between texture and earing has been reported based on calculation for ear height, taking only stress equilibrium conditions at the flange part and cup wall part during deep drawing into consideration, using the finite element analysis of a polycrystalline model<sup>4</sup>. From the result of this analysis, we know that negative ears develop in 0-90 degrees for Cube and Goss orientations while positive ears develop in 45-degree directions for S and C orientations.

In actual materials, there is a mixture of multiple textures. An ear is formed as a result of a weight average distribution of textures. The final development of ears occurs from the conditions above as well as various additional deep-drawing conditions and material strength of the actual material.

## 2. Measurement principle

We have focused on the fact that texture distribution indicates ultrasonic anisotropy based in view of the correlation between texture and elastic anisotropy. Relationship between texture, plastic forming and elastic anisotropy is shown in Fig. 3. As mentioned above, ears developing during deep

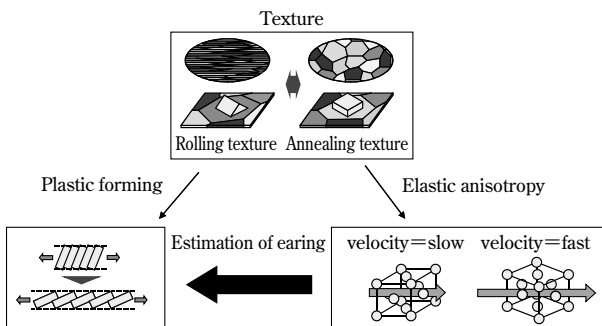

Fig. 3 Relationship between texture, plastic forming and elastic anisotropy

drawing processes are caused by textures, and their orientations are determined during the plastic deformation process of the deep drawing process. When ultrasound propagates, interatomic distances also fluctuate depending on directions, due to the unevenness in texture, resulting in fluctuation of the ultrasonic propagation speed, indicating acoustic velocity anisotropy. With the fracture method, earing is measured from plastic anisotropy upon its actual development. However, we have developed a method of measuring earing by focusing on the elastic anisotropy, and a device to measure ultrasonic anisotropy in various directions of an aluminum sheet<sup>4</sup>.

In order to measure earing using the ultrasonic anisotropy, we may measure the difference in acoustic velocity depending on propagation directions of ultrasound, in other words, if the propagation distance is the same, fluctuation in propagation time may be measured. To this end, an evaluation value to evaluate the ultrasonic anisotropy was defined in equation (2).

$$E = (T_{-45} + T_{+45}) - (T_0 + T_{90}) \text{ (ns)} \dots\dots\dots(2)$$

Letting the rolling direction be 0 degree,  $T_\theta$  is the propagation time for ultrasound propagating a set distance in a  $\theta$  direction.

While there are many propagation types for ultrasound, such as longitudinal waves, transverse waves, and a mixture of these two wave types, a plate wave causing vibration in the entire sheet (Lamb wave) was applied so as to measure ultrasonic anisotropy in the entire target aluminum sheet. Several vibration modes are known to exist among plate waves, and each of the vibration modes indicates velocity dispersion depending on sheet thickness x frequency<sup>5</sup>. Fig. 4 indicates the correlation between sheet thickness x frequency and velocity (calculated at 6,400m/s longitudinal wave and 3,040m/s transverse wave) for the ultrasonic propagation mode derived from theoretical calculation. In order to measure ultrasonic propagation time with stability and precision, it is necessary to have a method of measurement that can distinguish ultrasonic waveform of other vibration

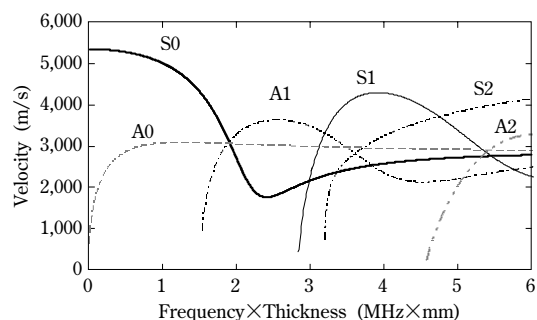

Fig. 4 Relationship between frequency, thickness and velocity

modes, and is capable of taking measurements in the low dispersion region. Based on such considerations, S0 mode without any overlapping vibration mode and having small velocity dispersion was selected.

When using a conventional piezoelectric device as an ultrasonic probe, a contact medium such as water or oil to propagate ultrasound in the target material becomes necessary. In such a case, measured propagation time would contain propagation time through the contact medium in addition to actual propagation time through the aluminum sheet. In other words, measuring texture-related ultrasonic anisotropy requires control of thickness of the contact medium at a submicron level, rendering it impractical. Therefore, an electro-magnetic acoustic transducer (EMAT)<sup>6)</sup>, without necessity of a contact medium, and capable of non-contact measurement useful in inline measurement, was selected.

Lorentz-type EMAT (its working principle is shown in Fig. 5) applicable to non-magnetic metals such as aluminum is used. It is comprised of a magnet and a coil. When a high-frequency current flows through a coil placed directly under a magnet, it excites an induced current in the material, generating ultrasound due to magnetostatic field and Lorentz force. The coil is a meander coil, making neighboring currents flow in opposing directions, causing Lorentz force to work in opposite directions as well, to develop a plate wave triggering vibration through the entire sheet. In terms of receiving ultrasound, the electromotive force induced in the coil is detected as the reception signal, from ultrasonic vibration on the material surface and the magnetostatic field based on the law of electromagnetic induction. Propagation time is measured in the direction of propagation in the aluminum sheet using this plate wave.

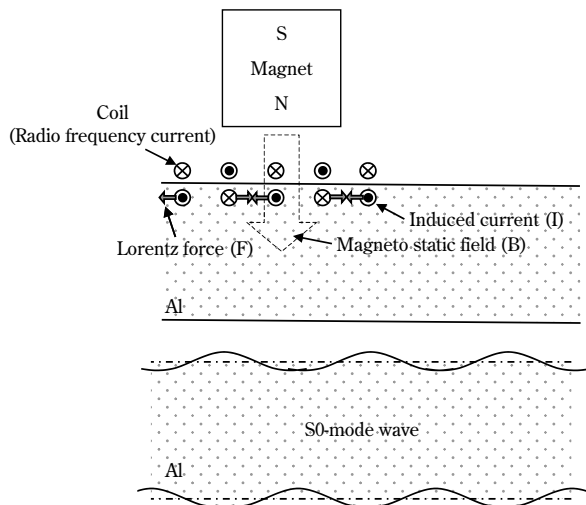

Fig. 5 Generation of S0-mode wave by EMAT

### 3. Equipment composition

#### 3.1 EMAT sensor

From the plate wave dispersion characteristics shown in Fig.4, it is clear that frequency x sheet thickness must be less than 1.5 (MHz x mm) in order to solely generate the S0 mode. Meanwhile, it is more desirable for ultrasonic frequency to be high from the aspect of ultrasonic measurement precision. Therefore, target aluminum sheet thickness was designated to be less than 1mm for this equipment, and ultrasonic frequency was established to be 1.35MHz.

A plate wave in a specific mode must match its phase with an EMAT sensor for efficient transmission and reception. At the frequency above (1.35MHz) with the sheet thickness of less than 1mm, acoustic velocities range between 5,000 and 5,400m/s. Wavelength of S0 mode plate wave is determined to be 4mm judging from the correlation between the frequency and sheet thickness above as well as the equation where acoustic velocity = frequency x wavelength. Thus, the EMAT sensor coil was produced as a meander coil with opposing coil pitches of 2mm, the number of turns at 9, and the distance between transmission and reception coils of 90mm.

Layout of the EMAT sensor for earing measurement is indicated in Fig. 6. In order to evaluate composition ratios for annealing texture and rolling texture, sensors were placed in four directions namely 0 degree, + and - 45 degrees, and 90 degrees (T① - ④: Transmission sensors and R ① - ④: Receiving sensors) and the plate wave in S0 mode was propagated in four directions through the aluminum sheet.

#### 3.2 System configuration

System configuration of the developed equipment is shown in Fig. 7. The function generator receives control signals from a PC to generate an ultrasonic oscillation waveform, which will be amplified by the RF power amplifier (RF power amp) with a maximum output of 5kW. Signal waveform is then sent to transmission EMAT sensor inside the sensor head via a channel switcher (Ch switch) to generate ultrasound in the target material (Al plate).

Ultrasound signal waveform received by the receiving EMAT sensor inside the same sensor head is sent to the receiver (Receiver) through a preamplifier (Pre-Amp). Received signals are converted to digital signals, and the propagation time is measured by performing a waveform analysis on a PC.

Ultrasonic propagation time in four directions

may be measured automatically by controlling with the channel switcher. Measurement time is about 2 seconds per location.

Fig. 8 shows the equipment appearance. A 19-inch rack houses both a measurement system and a signal processing system.

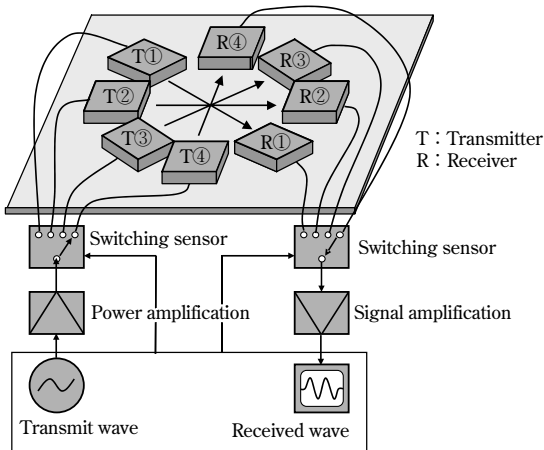

Fig. 6 Earring measurement by EMAT

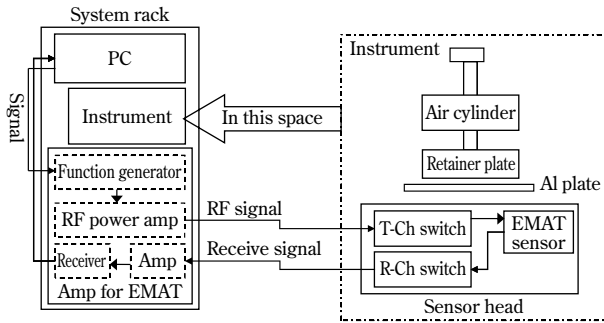

Fig. 7 System configuration

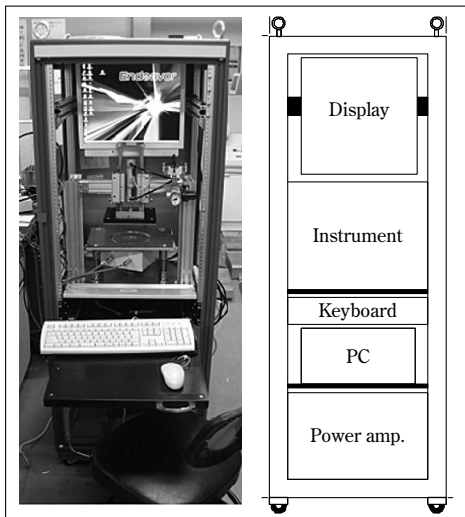

Fig. 8 Measurement system overview

## 4. Performance evaluation experiment result

### 4.1 Measurement result of ultrasonic anisotropy

An example of a received signal waveform measured by this equipment is shown in Fig. 9. According to Fig.9, the received signal is detected at approximately  $S/N=25$ . Also, Fig.10 shows the difference in propagation time between rolling direction and a 45-degree angle being the ultrasonic propagation direction. In this example, the difference in propagation time was about 30ns. Repeat accuracy for the earring measurement instrument is 0.1% for the earring. When calculating from the correlation between fracture method and measurement time of an EMAT waveform, the earring measurement instrument would need the time resolution of 2.5ns to measure the propagation time. Although pulse wave is suitable for detecting the difference in propagation time at high precision, it has a problem of being a single wave with insufficient signal strength. Therefore, burst wave was selected and arithmetic mean processing was used to improve  $S/N$  further. Also the difference in propagation time was calculated at high precision by taking cross-correlation with the reference waveform. Including the signal processing above, the measurement time for measuring four directions in one sample takes approximately 10 seconds.

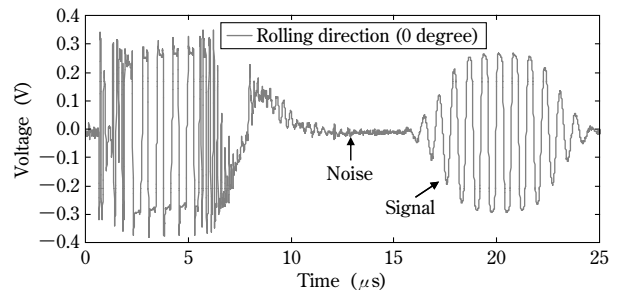

Fig. 9 Example of an ultrasonic waveform

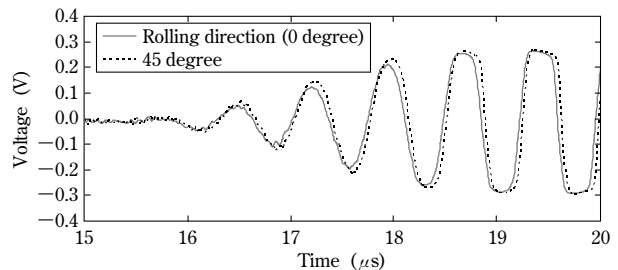

Fig.10 Difference of propagation time in various directions



## 4.2 Evaluation result of ultrasonic anisotropy and earing

Actual aluminum sheet samples were prepared with unique lot and charge for every product type by the MOKA PLANT, to conduct a confirmation experiment to evaluate if there was a correlation between the earing measured by fracture method and evaluation value  $E$  attained from the measurement by the EMAT earing measurement equipment. In order to make performance evaluation by the EMAT repeatable, an aluminum sheet from the same section was halved to be used for both the EMAT evaluation sample and for earing measurement by the fracture method. An example of correlation between earing by fracture method and ultrasonic anisotropy evaluation value  $E$  by EMAT for 3000 series (used for drinking can body material, etc.) grouped with keys such as corresponding material and sheet thickness is shown in Fig.11. Earing value by the fracture method is indicated on the y-axis, and evaluation value  $E$  by EMAT is indicated on the x-axis, and deviations from the calibration line are expressed as standard deviation. By grouping and calibrating measurement targets, it was confirmed from this result that evaluation values  $E$  and earing values have a linear relationship, and standard deviation  $\sigma$  (in earing %) became 0.05%. As a result, it was demonstrated that difference between the EMAT earing value and fracture method is within the target value of 0.5%, when using the evaluation value  $E$  for ultrasonic anisotropy shown by equation (2). Furthermore, it was confirmed that, in terms of stability, repeat measurement precision for three repetitions in one sample was 0.1%.

Measurement results for pure aluminum (1000 series: for condenser case application, etc.) are shown in Fig.12. Although the margin of error became greater when samples were grouped together as shown in Fig.12 (a), when they were categorized by heat treatment conditions as shown in Figs.12 (b) and (c), demonstrating a possibility of improving precision.

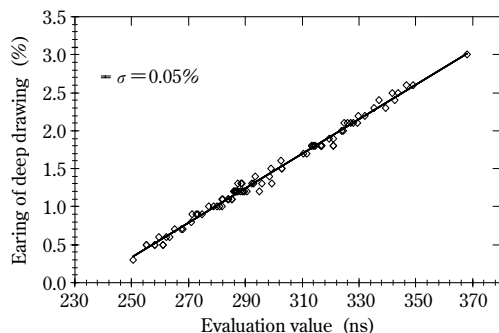

Fig.11 Correlation between earing of deep drawing and evaluation value

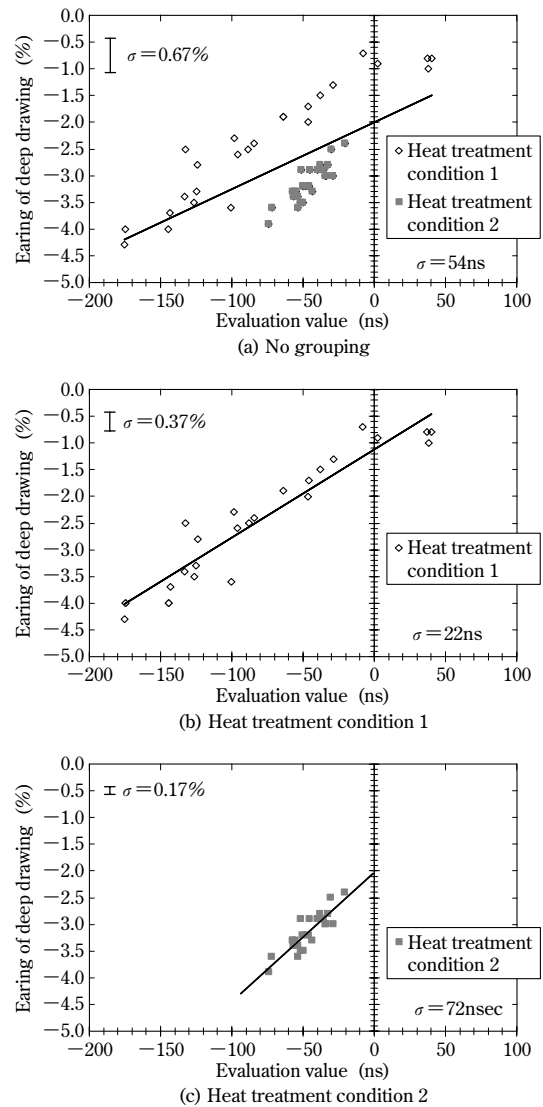

Fig.12 Correlation between evaluation value and earing occurring in the 1000 series

## 5. Consideration

Since a correlation between ultrasonic anisotropy and earing for various aluminum sheets with different product types and processes was observed, we may conclude that earing is strongly correlated with elastic anisotropy of initial texture. Therefore, there is a possibility that earing may be evaluated from the acoustic velocity measurement with universality by clarifying relationship between elastic characteristics and earing (plastic deformation).

However since plastic deformation for deep drawing fluctuate not only from the material, but also from processing conditions (such as lubricant and fold pressure) as well as from a combination of these conditions, it is considered more practical and realistic to calibrate in conjunction with materials and processing conditions. Calibration line for earing and evaluation value  $E$  for a 3000 series aluminum

sheet is expressed by the equation (3) in Fig.11.

Earing(%)=

$$0.0228 \times \text{evaluation value } E \text{ (ns)} - 5.361 \cdots \cdots (3)$$

Variance in the evaluation value  $E$  corresponding with variance of earing value at 0.5% was 22ns. Meanwhile, propagation time for transmission and reception by this equipment is transmission/reception distance (90mm)/acoustic velocity (5,000m/s) = 18,000ns. In order to evaluate earing with 0.5% resolution, acoustic velocity must be measured stably at 0.1% precision. As shown by the dispersion characteristics in Fig.4, acoustic velocity depends on the sheet thickness in addition to textures, fluctuation in sheet thickness contributes to creating an error. Unlike conventional piezoelectric sensors, ultrasonic frequency may be easily changed for EMAT, allowing for compensation of the sheet thickness fluctuation in frequency dependence of acoustic velocity.

## Conclusions

Upon acquiring and confirming calibration data at the Quality Assurance Section of the MOKA PLANT, EMAT-based earing measurement equipment focusing on ultrasonic anisotropy was developed as a possible alternative technology for conventional earing measurement approach for plastic anisotropy in deep drawing processes. As a result, we have found that it is possible to predict earing by 0.5% ( $1\sigma$ ) of the fracture method, by establishing a calibration line for each set of product types and manufacturing conditions. We have also confirmed that 3000 series for drinking can bodies having a high production

volume may likewise be predicted for anisotropy at 0.05% ( $1\sigma$ ). We will continue to compare precision of EMAT earing measurement equipment against fracture test results for each of the product types in detail to consider the possibility of using it as a replacement technology for fracture tests.

The largest advantages of the developed equipment are absence of a contact medium and rapid measurements. This will not only allow for inspecting a larger number of locations, but will propose potential applications for all units or entire length inspections as well as inline monitoring at latter stage of manufacturing processes. We would also like to explore a larger scope of applications including implementations for steel and copper, as well as acoustoelastic measurement<sup>7)</sup> of stress capitalizing on minute fluctuation in ultrasonic acoustic velocity caused by stress conditions of the medium.

## References

- 1) The Japan Society for Technology of Plasticity. *Press Work Handbook*. Maruzen Co., Ltd., p.340.
- 2) D. Altenpohl. *Une introduction a la metallurgie structurale et a la transformation de l'aluminium*. 1971, p.94-95.
- 3) Naoyuki Kanetake et al. *Light Metals*. 1982, Vol.32, No.5, p.241-246.
- 4) Takeo Ogawa et al. *Proceedings of 7th Nondestructive Evaluation Symposium*. 2000, p.47-54.
- 5) The Nikkan Kogyo Shimbun, Ltd. *Ultrasonic Inspection*. p.65-71.
- 6) Riichi Murayama. *Nondestructive Testing*. 2009, Vol.58, No.7, p.262-268.
- 7) Hidekazu Fukuoka et al. *Introduction and Application of Acoustoelasticity*. Ohmsha, Ltd., 1993, 200p.