

# KOBELCO

*October 1998*

*Vol.1 (No.4)*

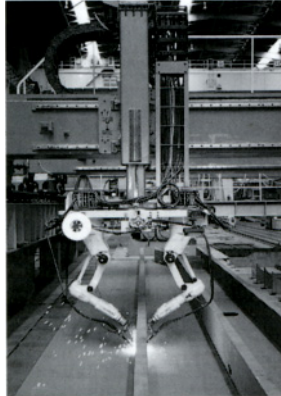
# WELDING TODAY





## Samsung's Goal for the 21st Century: To be the Worlds No.1 Shipyard

On Koje Island, at the southeastern end of Korea, there is the Kohyun Bay. It is a one-hour trip from Korea's No. 2 city of Pusan. Facing this bay, is the Shipbuilding and Plant Engineering Division of Samsung Heavy Industries Co., Ltd. Established in 1977, this division operates the world's third-largest shipyard with a huge shipbuilding capacity, and is also a steel fabricator of bridges architec-



*Robotic welding with DW-100 in the subassembly panel line (Above)*

tural structures, offshore plants and transportation equipment. The shipbuilding division equips three dry docks and has a shipbuilding capacity of 1.8 million gross tons per year.

In the fabrication of these heavy and huge steel structures, welding is one of the main procedures. In the 1970s, shielded metal arc welding was a key process. In the early 1980s, the company employed CO<sub>2</sub> arc welding. Nowadays, CO<sub>2</sub> arc welding with flux-cored wires is a predominant process with an 84% consumption ratio. And the most commonly-used brand is a low-fume type DW-100.

When the company increased capacity with the opening of a third dry dock in 1995, they promoted rationalization and automation in the welding work for the production of ships by exploiting advanced welding procedures and improving the physical distribution system. Examples are:

- (1) Higher fabrication efficiency in the panel line has been achieved with the world's first custom-made turning devices, which simplify the turning over of main steel plates for back-and face-side submerged arc welding.
- (2) Three sets of unique automatic fillet welding equipment can weld both sides of five longitudinal components simultaneously.
- (3) Custom-made welding robots improve the productivity in sub-assembly lines — see photographs.

- (4) Off-line-teaching robots automate the fillet welding in the assembly stage.

The successful construction of both ships and offshore structures has led customers to be assured of the company's technical capability. This success includes the recent construction of such a special-feature ship as FPSO, the design of which is very different from ordinary trading vessel: a drill ship; and Korea's first corrugation type LNG carrier.



*Samsung's shipbuilding dock (Above)*

In addition to sub-assembly and assembly stages, the company has a plan to promote the employment of welding automation for erection stages. This would include automatic welding of curved blocks, no-gap-one-side CO<sub>2</sub> arc welding, and highly efficient procedures in multi-pass CO<sub>2</sub> arc welding for thick plates, horizontal fillet and vertical butt welding. The implementation of this plan is accelerated by the utilization of advanced welding consumables with higher efficiency and quality.

In the utilization of welding automation and robotic systems, it is most important to control accuracy in the production stages, from the cutting of plates to assembly of hull blocks. The company, therefore, emphasizes upgrading the accuracy control system taking into account both theory and practice. Aiming to be the world's No 1 shipyard for the 21 st century, the company is sure to create an ideal shipyard at which the world will stare in surprise.

(Reported by Mr. T. W. Jang/Manager/Samsung)  
(Arranged by Mr. D. S. Kim/Manager/McQAN)



# LB-52U

(AWS A5.1 E7016)



LB-52U is the world's No. 1 covered electrode for "uranami" welding, or the root pass melt-through welding with penetration beads. With LB-52U your welding will be easier and faster, and you will have confidence in the quality of your welds in any kind of pipe welding of mild steel and 490N/mm<sup>2</sup> high tensile steel.

## Inception of LB-52U

LB-52U was developed around 1954. The letter "L" stands for low hydrogen, while "B" symbolizes a slag shielding covered electrode. The digits "52" refer to the level of approximate tensile strength of the deposited metal when it was developed. The letter "U" was coined from "uranami" welding.

## What Makes LB-52U the Best for "Uranami" Welding?

(1) Unsurpassed usability in all-position welding

LB-52U features a very stable arc and low spatter over a wide range of welding currents. In particular, LB-52U really shines in the "uranami" welding of horizontally fixed pipes.

LB-52U features very smooth, glossy "uranami" beads, or the penetration beads protruded on the reverse side of the groove — Fig. 1. LB-52U can

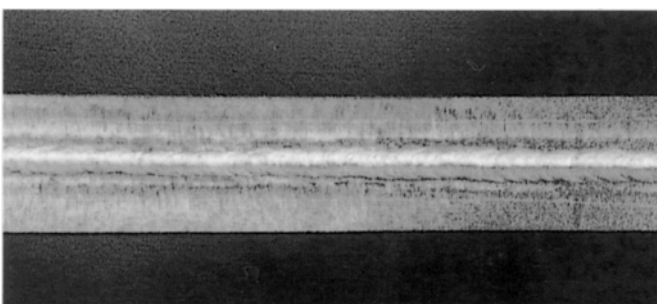


Fig. 1 — An "uranami" bead, or the penetration bead protruded on the reverse side of the groove

accommodate wider tolerance of the root opening, which is an advantage in site welding. Once you have used LB-52U, you will choose it again and again for unsurpassed performance.

(2) Superior crack resistance and mechanical properties

LB-52U provides superior crack resistibility due to a lower level of diffusible hydrogen in the weld metal. In addition, its impact strength is high over a range of testing temperatures — Fig. 2. Therefore, it can be used for low-temperature applications as well as moderate high-temperature applications.

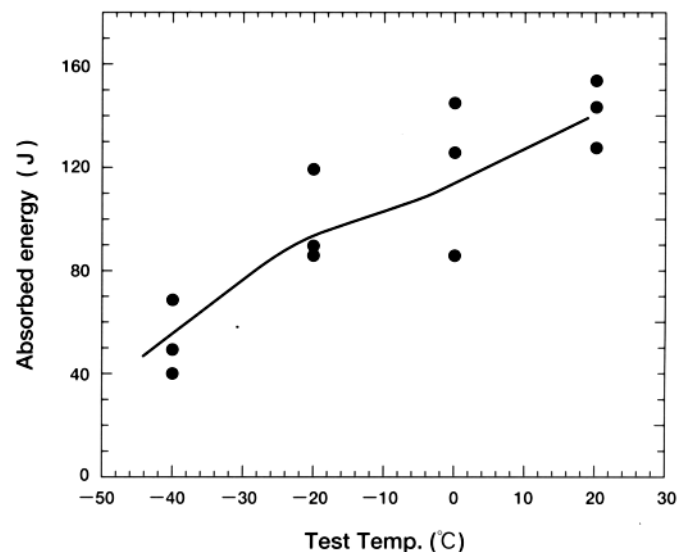


Fig. 2 — Charpy impact test results of the LB-52U weld metal by using DC-EP welding current in the vertical-up position

(3) A field-proven electrode in the worldwide markets

The unsurpassed usability of LB-52U in the "uranami" welding of pipe joints has satisfied users around the world. LB-52U has been popular for a variety of piping jobs across Russia, Asia and the Pacific region. Particularly in Russia, LB-52U has made a great contribution to the construction of

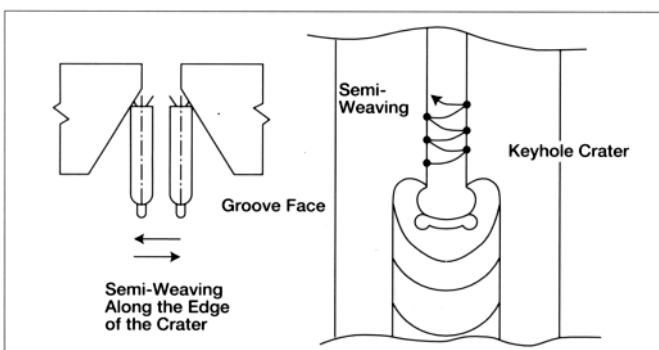


**Fig. 3 — A pipeline-welding site in Russia where LB-52U is used for joining the girth joints in freezing weather**

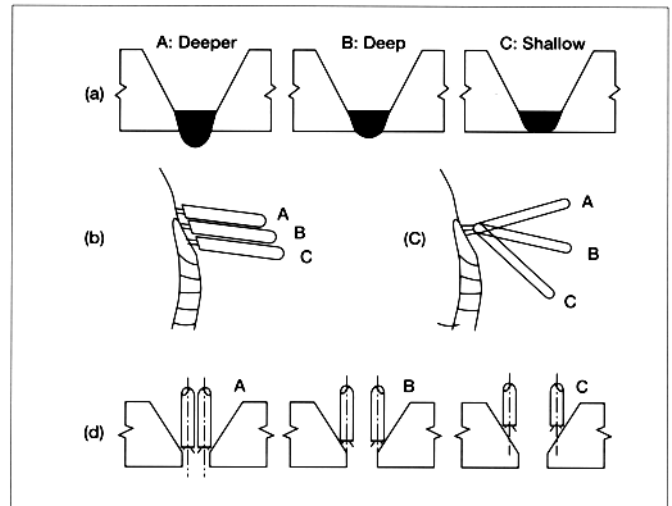
very long, oil and gas pipelines under freezing weather with a long history of reliability — Fig. 3. Since 1982 more than 20,000 metric tons of LB-52U has been consumed in the construction of the Russian pipelines.

### Key Points in the "Uranami" Welding of Pipes with LB-52U

- (1) Use the keyhole technique. Right after you get the arc by striking the groove face, control the molten pool to form the keyhole crater: then manipulate the electrode along the edge of the keyhole by using the semi-weaving technique — Fig. 4.

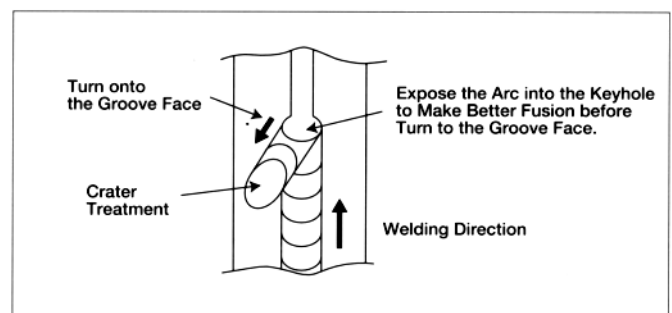


**Fig. 4 — The keyhole technique**



**Fig. 5 — The relationship between the weld penetration (a), the arc exposure spot (b), the electrode holding angle (c) and the electrode oscillation width (d) in the "uranami" welding of horizontally fixed pipes**

- (2) Control the weld penetration in the root of the groove by controlling the arc exposure spot, the electrode holding angle and the electrode oscillation width — Fig. 5 (a, b, c, d). Fig. 5 (a) relates to the other figures of (b), (c), and (d) respectively.
- (3) Terminate the crater on the groove face in order to prevent the crater cracking — Fig. 6.



**Fig. 6 — How to terminate the weld crater in order to prevent the crater from cracking**

- (4) Grind both the starting and ending terminals of the preceding weld beads to assure a smooth joint of weld beads with the succeeding welds.
- (5) When joining the weld beads, start the arc on the preceding bead, and expose the arc into the keyhole to assure better fusion: then follow the same procedure as in Fig. 4.

# DW-316L

(AWS A5.22 E316LT0-1, E316LT0-4)



DW-316L is an advanced stainless flux cored wire that significantly reduces spatter and fumes over a range of welding parameters and features self-peeling slag removal and glossy bead appearance.

## Basic Characteristics of DW-316L

DW-316L is suitable for welding both 316L and 316 stainless steel in flat and horizontal positions. As for shielding, either CO<sub>2</sub> gas or 75-80%Ar+CO<sub>2</sub> gas mixtures can be used.

## What Makes DW-316L an Advanced Wire?

Properly controlled ferrite content (typically 8% by Schaeffler Diagram) in DW-316L weld metal provides excellent resistibility to hot cracking. Low carbon content (typically 0.026%) in the weld metal provides superior resistance to intergranular corrosion. The sophisticated chemical composition of the weld metal provides outstanding mechanical properties and corrosion resistibility against diluted sulfuric acids in particular.

DW-316L significantly lessens spatter by 40-50% when compared with conventional stainless flux cored wire. DW-316L features convenient self-peeling slag removal and glossy bead appearance. Because less postweld cleaning is required to remove spatter and slag, material and labor costs can be reduced. DW-316L also produces 20-25% less fumes compared with conventional stainless flux cored wire. This improves the work environment for welders.

DW-316L also provides higher deposition rates than covered electrodes and solid wires — Fig. 1. For instance, the deposition rate of DW-316L can be about three times that of covered electrodes, which means

you can fill a welding groove three times faster, increasing productivity while decreasing labor costs.

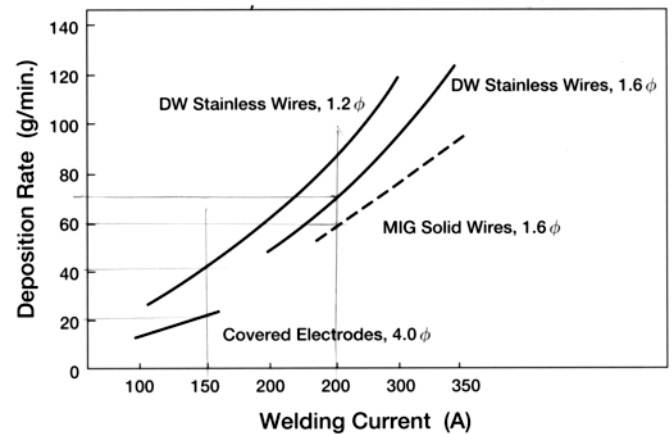


Fig. 1 — A comparison on deposition rates between flux-cored wires, MIG solid wires and covered electrodes as a function of welding currents.

Because of the superior corrosion resistibility, mechanical properties and usability, DW-316L is often used for welding some components of chemical tankers that require stricter quality of the welds — Fig. 2.

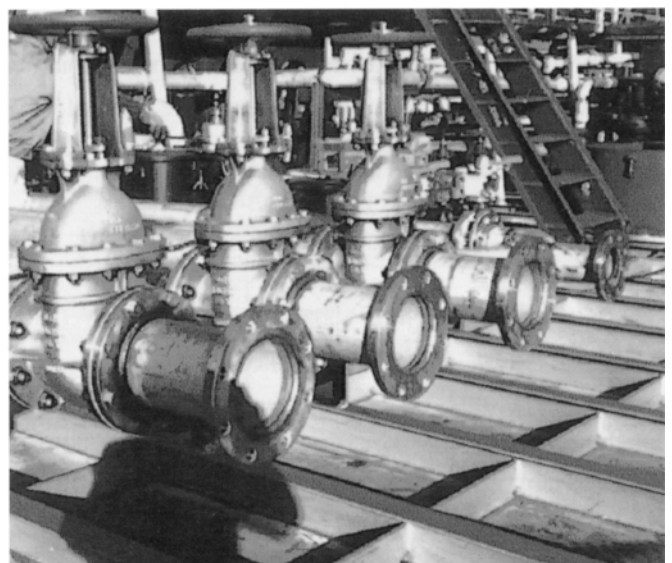


Fig. 2 — An application of DW-316L for fillet welding of the pipefitting of a chemical tanker.



# DW-316LP

(AWS A5.22 E316LT1-1, E316LT1-4)

DW-316LP is an advanced stainless flux cored wire that offers unsurpassed usability in all positions including flat, horizontal, vertical-up, vertical-down, and overhead.

## Basic Characteristics of DW-316LP

DW-316LP is suitable for welding in all positions with either CO<sub>2</sub> gas or 75-80%Ar+CO<sub>2</sub> gas mixture shielding. DW-316LP can be used for welding both 316L and 316 stainless steel.

## What Makes DW-316LP an Advanced Wire?

Like DW-316L, the chemical composition of the DW-316LP weld metal provides superior mechanical properties and corrosion resistibility particularly against diluted sulfuric acids.

DW-316LP also offers excellent welding performance in all positions and over a range of welding parameters. Fig. 1 shows an example of proper welding parameters

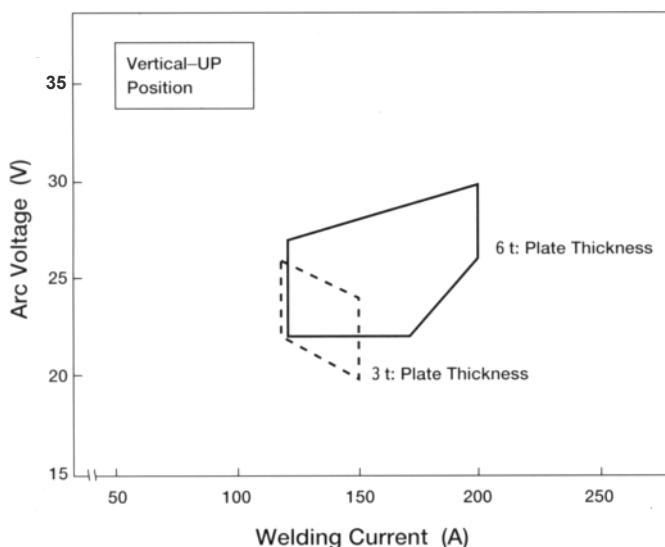


Fig. 1 — The proper welding currents and arc voltage in the vertical-up position using a 1.2-mm DW stainless wire.

in the vertical-up position. Once you adjust the welding current to 160-170A. for example, you can properly weld a 6-mm-thick stainless plate in any of the flat, horizontal, vertical and overhead positions without any current readjustment.

Because of the superior corrosion resistibility, mechanical properties and out-of-position usability, DW-316LP is often used for welding storage tanks of chemical tankers — Fig. 2.

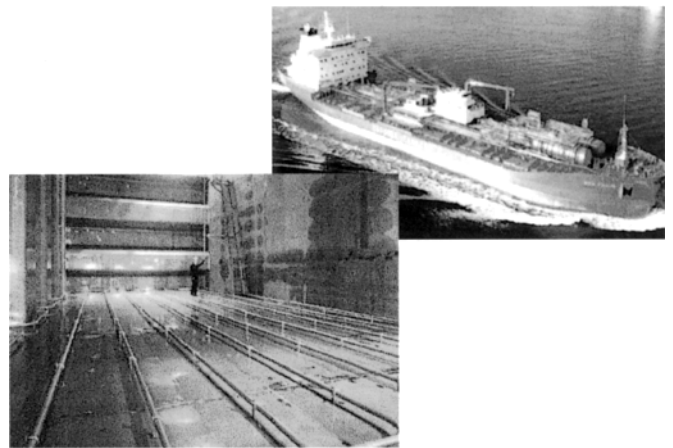


Fig. 2 — An application of DW-316LP: welding a storage tank (above) of a chemical tanker (top) with full penetration in all positions.

Fig. 3 shows an example of the welding procedures for the butt joints of a chemical tanker storage tank.

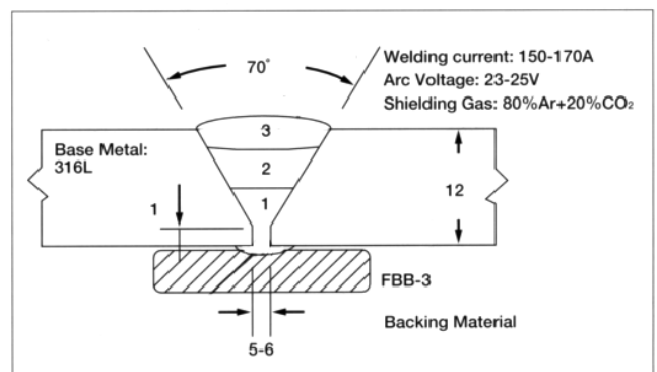
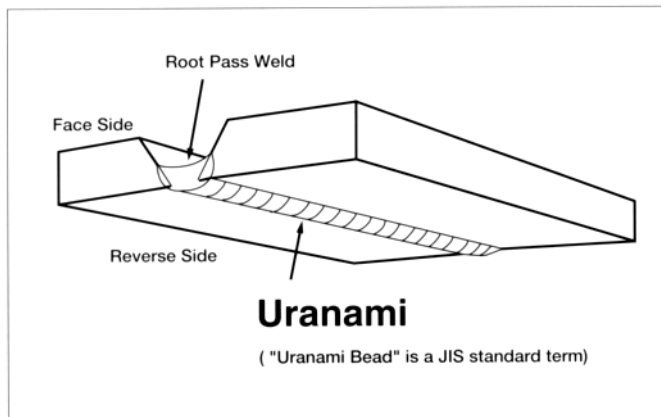


Fig. 3 — An example of the welding procedure used for a storage tank of a chemical tanker. This is a one-side welding process using the FBB-3 refractory backing material in vertical-up position.



## What is "Uranami," and How Useful is it?

The term, "uranami," is the literal pronunciation of the two-word Japanese technical term "裏波." "Ura" literally means, "reverse side," and "nami," "ripples." "Uranami" is used to describe the penetration bead protruded on the reverse side of the groove when welded from the face side of the groove (one-side welding without backing materials) — Fig. 1.

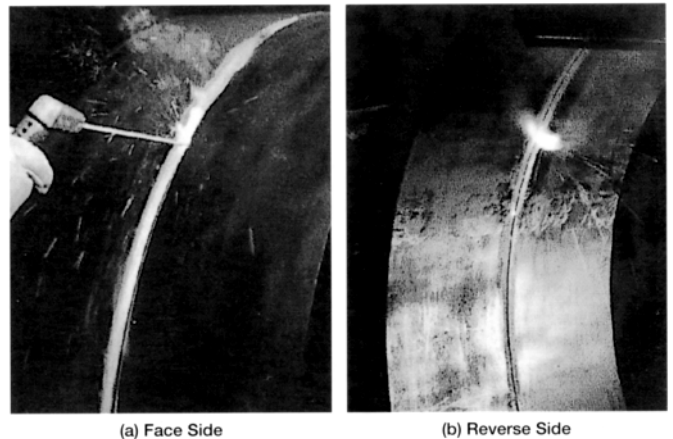
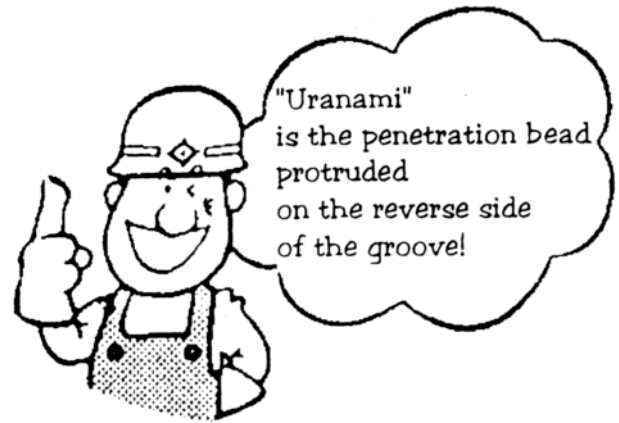


**Fig. 1 — The uranami is the penetration bead protruded on the reverse side of the groove when welded from the face side of the groove (one-side welding without backing materials).**

"Uranami" has been used in the welding field in Japan for quite some time. This term was common already in 1954, when LB-52U was developed. LB-52U is now called the "uranami" electrode, or an exclusive-use covered electrode for "uranami" welding (one-side welding without backing materials). The JIS standard now specifies "uranami" bead, to mean "penetration bead."

"Uranami" welding is one of the one-side welding processes, but no backing material (steel backing, refractory backing, weld backing, or gas backing) is used. Therefore, the "uranami" electrode is ready to use for one-side welding without any need to prepare backing material or equipment (backing and clamping jigs) — Fig. 2.

The term, "uranami," can be used for other one-side welding procedures as well as for "uranami" welding with an "uranami" electrode in shielded metal arc welding. Any of the penetration beads can be called



**Fig. 2 — The "uranami welding" process, or a one-side welding process without any backing material and equipment on the reverse side of the groove.**

"uranami" in one-side welding procedures with the backing material and equipment in submerged arc welding, gas metal arc welding, gas tungsten arc welding and electrogas arc welding.

"Uranami" welding offers a very economical procedure. It can save labor and material costs in the preparation of the backing material and equipment in one-side welding, and for the back gouging of full-penetration joints. "Uranami" welding, therefore, is very useful in the construction of in-plant piping systems, cross-country pipelines and tubular structures.

In "uranami" welding, however, welders should use the specific techniques as stated in the column of "LB-52U" in this issue. In controlling the root penetration, the protrusion, or the reinforcement of "uranami" should also be controlled within the specification you have to follow.



## "QTQ" is Ready at the KWAI Web Site on the Internet

Only a few years ago the business community was overwhelmed with the introduction of the Fax Machine, if a company did not have a fax they were considered very inefficient and difficult to do business with. Today we are now seeing this same phenomenon with the Internet, a presence on World Wide Web will soon be a necessity.

As a respected leader in the welding industry Kobelco Welding of America Inc. announces the creation and opening of our World Wide Web Address WWW.kobelcowelding.com, also the availability of E-Mail correspondence through individual address's or general delivery at kobelco@kobelcowelding.com.

KWAI currently has product and parameter information available online, and we plan to add our MSDS, Data Sheets, and Technical Documentation, for our End Users, and Distributors, to reference, download or print. Links to our trading companies will be added, along with a news section for announcements, events, and changes. We feel having this information on the Internet well virtually, eliminate the need for mailing or faxing."

The addition of the KWAI web site, is another facet of our continued commitment of making KWAI easier for our customers to reach and work with, and is also in keeping with our QTQ Slogan: Quality Products, Technical Support, Quick Delivery.

(Reported by Mr. Dan Johnson/Manager/KWAI)



Quick response, colorful design and a lot of useful information on the Internet: a page of "Products" (Left), and a message in the page of "Company Info"(Bottom).

KOBELCO Fluxed Cored Wire of unsurpassed quality and that's not just an idle boast or wishful thinking. Just ask any professional welder who has used Kobelco's flux cored wires.

Kobelco's consistent quality begins in our welding R & D Department that is continually studying new materials and processes. New discoveries that result in flux cored wire with less spattering and easy slag removal. Wires with excellent arc stability and smooth wettability that produce a beautiful bead...spool after spool.

And you won't have to worry about availability. Because we're the Welding Division of Kobe Steel, our warehouses are always stocked to meet your needs. In many cases, an order placed today means and order delivered tomorrow. Not weeks or months from now.

So weld with the best: Kobelco.

## An Impressive June Bride in the UAE

I was just leaving for the Middle East on business last June, when I received an invitation card to a wedding reception from a sales agent in the United Arab Emirates (UAE), who represented the "Technical Parts Company." We were going to have a sales meeting in Abu Dhabi, but I didn't have a single spare day in my original itinerary. However, because of the generous invitation, I extended my itinerary by one day to attend the reception.

The venue for the wedding reception was at a hotel in Dubai, which is as big a city as Abu Dhabi. The reception started at 9 o'clock in the evening, maybe to avoid an ambient temperature as high as 45°C in the day time. It was a big reception, attended by about 1,300 guests.



*With the happiest smiles the bridal pair welcomes the guests (Left)*

The bridegroom was a son of the director of the sales agent, and the bride was a daughter of the owner. So this was a grand celebration that proclaimed their business connections.

Since the bridal pair were from families of Indian origin (large numbers of ethnic Indians live and work in the UAE), the entire atmosphere of the reception had an Indian flavor. The dinner was buffet style. Guests put their favorite foods on a plate, and enjoyed them at a table as usual. Liquor was served, too, since the UAE is a rather liberalized country in the Middle East.

Women at the reception were in bright and colorful traditional saris, decorated with floral patterns. As for the men at the reception, they were very keen on chatting with business connections. To me, from Japan, everyone at the reception seemed to be in a mood for socializing.



*Women in bright and colorful saris look like flowers (Right)*

There were no speeches and sideshows at the reception, which is different from Japanese tradition. Rather it was one long celebration with lots of eating, drinking and congratulating. On the stage, the bride and bridegroom and their families accepted congratulations from the guests. I congratulated the bridal couple, offering a Japanese traditional doll as a present. This present seemed well-received and garnered a lot of praise, "It's wonderful."

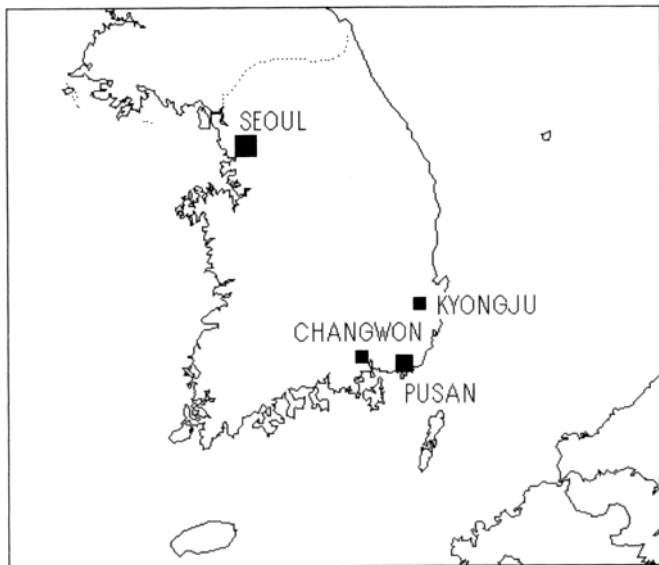


*A highly-appreciated Japanese traditional doll for the bridal pair (Right)*

There was still no sign that the reception would end, even after continuing for three hours with the same festive atmosphere. It seemed likely to continue until the next morning. So, I said goodbye after midnight passed. Just as in happy occasions in any country, they offered thanks again and again for my attending all the way from Japan. It was a rare experience for me, which helped me to develop a deeper connection with this sales agent. It was a very pleasant wedding reception with an impressive June bride with tears in her eyes.

(Reported by: Mr. K. Sugiyama, IOD, KSL)

## Traveler's Tales: Thinking of the Korean Ancient Era for a Little While



*KWK is located in ChangWon-city. (Above)* A two-hour, highway drive north from ChangWon-city, where Kobe Welding of Korea is located, took us to KyongJu-city. The city of KyongJu, which has a historical atmosphere, was the Capital City of the 1000-Year Silla Dynasty.

This time we visited the KyongJu National Historical Museum. All the green leaves around were brightening as a rain shower had just passed over, and everything we saw seemed to have a firm will. This atmosphere made us remember the Korean word that expresses a firm will: "Accomplish the Impossible." This indomitable spirit may have been inherited continuously since era before the Silla Dynasty. In KyongJu-city, we felt a wind blowing since ancient times.



*Posing are the reporter and his colleagues at the National Historical Museum (Above)*

---

### Editorial Postscript

---

Listed in the following are the welding trade fairs and exhibitions where Kobe Steel, Kobelco-group companies and business collaborators are scheduled to attend as exhibitors. We are looking forward to seeing you at Kobelco's booth.

- (1) Weld Expo Canada, Toronto,  
October 20-22, 1998
  - Kobelco Welding of America Inc.
  - Kanematsu Canada Inc.
- (2) CSMAQ '98. Sao Paulo, Brazil,  
November 17-20, 1998

- Kobe Steel, Ltd.
  - Kobelco Welding of America Inc.
- (3) Weldtech Asia '98, Suntech City, Singapore,  
December 1-4, 1998
    - Kobe Steel, Ltd.
    - Kobe Welding (Singapore) Pte. Ltd.
  - (4) Weld India International 1999 Exhibition.  
New Delhi, February 12-17, 1999
    - Kobe Steel, Ltd.
    - Nikko Boeki Kaisha Ltd.
    - Weldwell Speciality Pvt. Ltd.

## KOBELCO WELDING TODAY

October 1998, Vol.1 (No.4)

Publisher: The International Operations Dept., Welding Div., Kobe Steel, Ltd.

Printer: Fukuda Printing Co., Ltd.

Editor: KOBELCO WELDING TODAY Editorial Staff

URL: <http://www.kobelco.co.jp>



WELDING CONSUMABLE

# KOBELCO

THE WORLDWIDE MANUFACTURER

## GLOBAL MANUFACTURING AND SALES BASES

**JAPAN :**  
KOBELCO WELDING OF JAPAN CO., LTD.  
International Operations Dept.  
KOBELCO Bldg., 3-2 Toyo 2-chome, Koto-ku, Tokyo 135-8381  
JAPAN  
Tel. (81)3 5634-5031 Fax. (81)3 5634-5047

**EUROPE :**  
KOBELCO WELDING OF EUROPE B.V.  
Eijsterweg 8, 6422 PN, Heerlen, The Netherlands  
Tel. (31)45-547-1111 Fax. (31)45-547-1100

**USA :**  
KOBELCO WELDING OF AMERICA INC.  
7478 Harwin Drive, Houston, Texas 77036, USA  
Tel. (1)713 974-5774 Fax. (1)713 974-6543

**KOREA :**  
KOBELCO WELDING OF KOREA CO., LTD.  
21-14, Palryong-Dong, Changwon, Kyongnam, Republic of Korea  
Tel. (82)551 92-6886 Fax. (82)551 92-7786

**SINGAPORE :**  
KOBELCO WELDING (SINGAPORE) PTE. LTD.  
20, Pandan Avenue, Jurong, Singapore 609387, Republic of Singapore  
Tel. (65)2 68 27 11 Fax. (65)2 64 17 51

**THAILAND :**  
THAI-KOBELCO WELDING CO., LTD.  
500, Soi 1, Bangpoo Industrial Estate, Sukhumvit Road,  
Praeksa, Samutprakarn 10280, Thailand  
Tel. (66)2 324-05 88 - 91 Fax. (66)2 324-07 97

**KOBELCO WELDING (THAILAND) CO., LTD.**  
491, Soi 1, Bangpoo Industrial Estate, Sukhumvit Road,  
Praeksa Samutprakarn 10280, Thailand  
Tel. (66)2 324-05 88 - 91 Fax. (66)2 324-07 97

**MALAYSIA :**  
ST KOBELCO WELDING (MALAYSIA) SDN. BHD.  
Plot 502, Jalan Perusahaan Baru, Kawasan Perusahaan  
Prai, 13600 Prai, Malaysia  
Tel. (60)4-3905792 Fax. (60)4-3905827

**INDONESIA :**  
P.T. INTAN PERTIWI INDUSTRI  
(Technically-Collaborated Company)  
Jalan P Jayakarta 45, Block A/27,  
Jakarta 11110, Indonesia  
Tel. (62)21-639-2608 Fax. (62)21-649-6081

**PHILIPPINES :**  
WELDING RESOURCES INTERNATIONAL INC.  
(INDUSTRIAL WELDING CORPORATION)  
(Technically-Collaborated Company)  
No. 10, R. Jacinto Street, Canumay, Valenzuela, Metro Manila,  
1440, Philippines  
Tel. (63)2-292-6968 Fax. (63)2-292-6974

INTERNATIONAL SLOGAN KOBELCO WELDING GROUP

# Q T Q

**Quality Products    Technical Support    Quick Delivery**