

KOBELCO

January 2005

Vol.8 (No.1)

WELDING TODAY

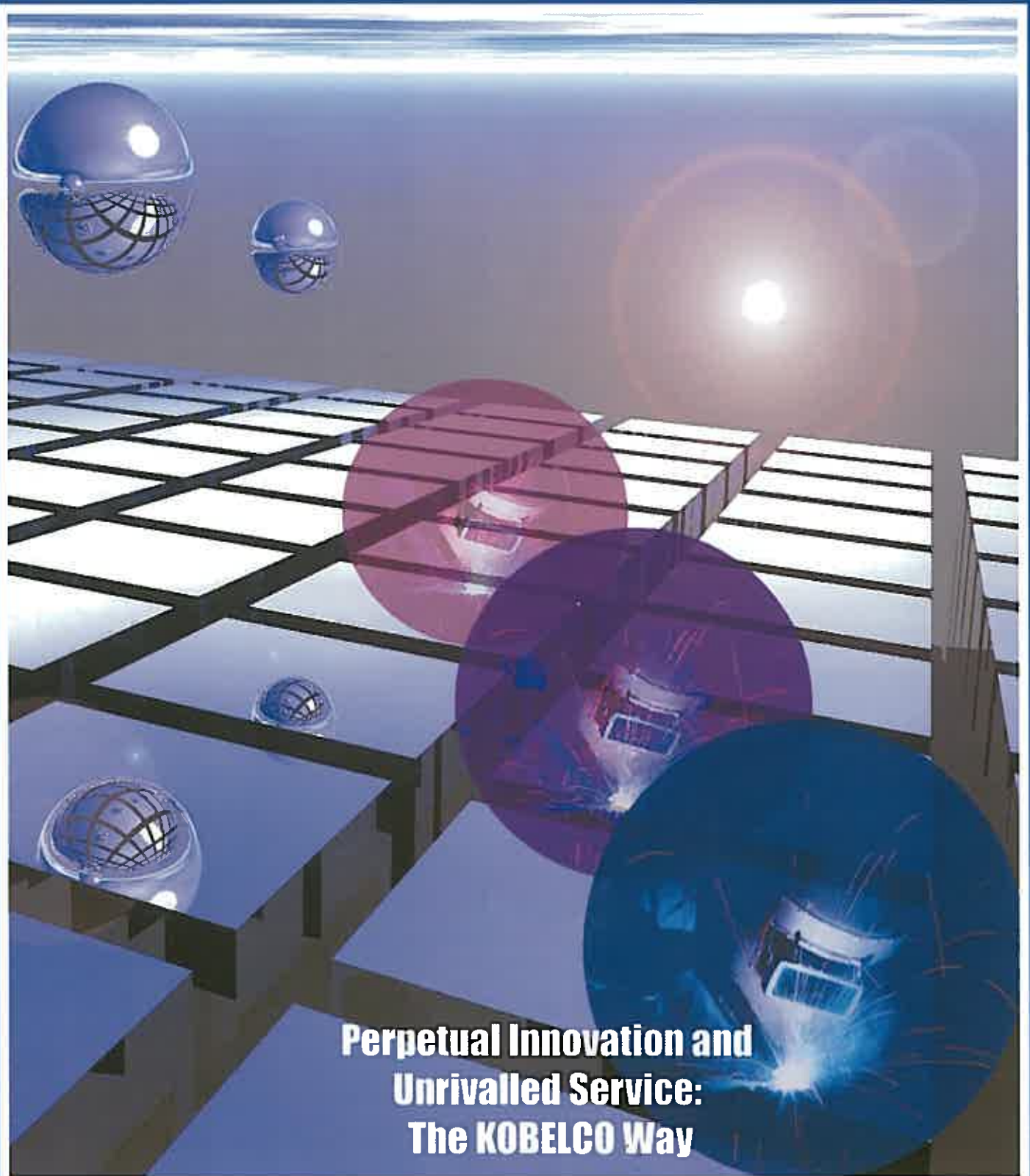

**Perpetual Innovation and
Unrivalled Service:
The KOBELCO Way**

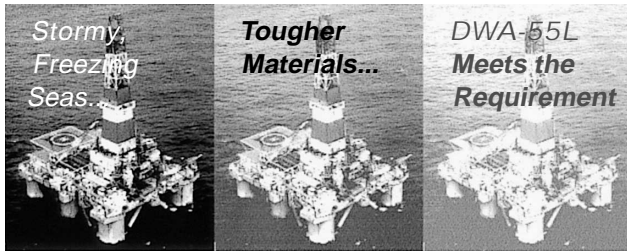

DWA-55L (AWS A5.29 E81T1-K2M, EN 758 T46 6 1.5Ni PM 1 H5) satisfies the latest stringent requirements - YS \geq 470 MPa, TS \geq 550 MPa, IV at - 60 \geq 60 J (av.) and 42 J (min), and CTOD at - 36 \geq 0.10 mm. This unsurpassed quality has been ensured by the sophisticated chemical compositions (1.5%Ni-Ti-B type) as shown in **Table 1**, thereby facilitating the consistently fine microstructure of the weld metal even in the as-cast or dendritic zone (**Figure 1**).

Table 1. Chemical and mechanical properties of DWA-55L deposited metal with 80%Ar-20%CO₂

| Chemical composition (%) | | | | | | 0.2%PS (MPa) | TS (MPa) | EL (%) |
|--------------------------|------|------|------|------|-------|--------------|----------|--------|
| C | Si | Mn | Ni | Ti | B | | | |
| 0.06 | 0.30 | 1.15 | 1.41 | 0.06 | 0.003 | 558 | 626 | 27 |

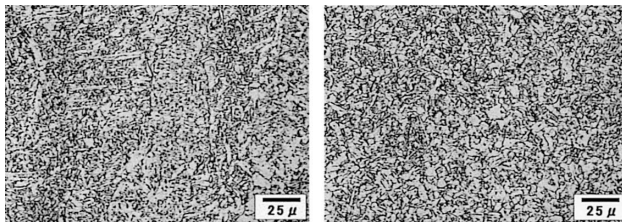

Figure 1. Ti-B micro-alloyed fine microstructures of DWA-55L weld metal with 80%Ar-20%CO₂ (Heat input: 1.7 kJ/mm)

With the fine microstructure, DWA-55L exhibits excellent Charpy impact and CTOD toughness as shown in **Figure 2** and **Table 2**, respectively.

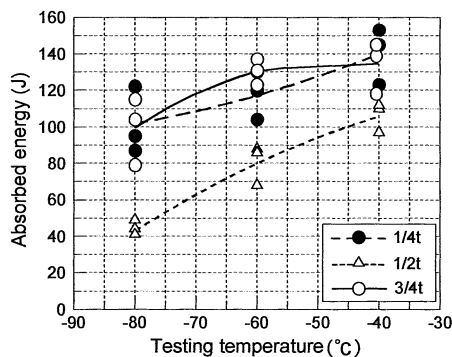

Figure 2. Charpy impact toughness of DWA-55L weld metal (60-mmT base metal, double bevel groove, 80%Ar-20%CO₂, vertical welding position, 1.8-kJ/mm heat input)

Table 2. CTOD values of DWA-55L weld metal⁽¹⁾

| Base metal ⁽²⁾ | Heat input (kJ/mm) | Test temp. () | CTOD (mm) ⁽³⁾ |
|---|--------------------|----------------|--------------------------|
| SM490A, 60 mmT, Double bevel groove joint | 1.8 | - 40 | 0.38 |
| | | | 0.79 |
| | | 0.43 | |
| | 1.1 | - 36 | 0.88 |
| | | | 0.37 |
| | | - 40 | 0.56 |
| - 36 | 0.84 | | |
| | 0.90 | | |
| | | | 0.53 |
| | | | 0.93 |

Note:

(1) 80%Ar-20%CO₂, vertical welding position

(2) Rolled steel as per JIS G 3106

(3) Testing method: BSI BS7448-91 (Specimen size: W = B)

With higher heat input, the strength of the weld metal tends to decrease and the impact toughness is apt to be affected more largely by the testing temperature as shown in **Figure 3**. Hence, these factors should be controlled in welding procedures. Recommended preheat and interpass temperature is 150 . Recommended welding currents and arc voltages are shown in **Figure 4**.

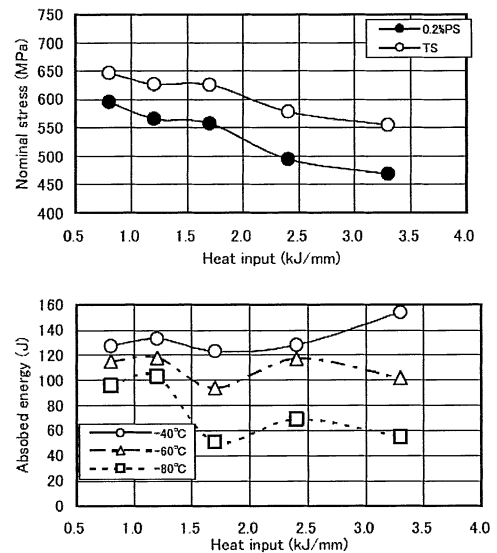

Figure 3. Heat input vs. strength and impact toughness of DWA-55L weld metal (80%Ar-20%CO₂)

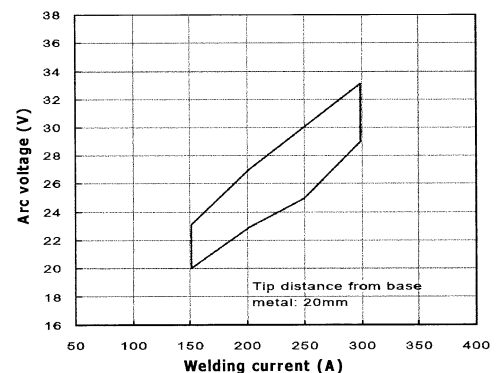

Figure 4. A-V range for DWA-55L (1.2 , 80%Ar-20%CO₂)

A Happy New Year to Dear KWT Readers!!

In Japan we celebrate the New Year from the first to seventh of January, especially for the first three days of the year. During the days from January 1 to 7, which we call "Matsu-no-Uchi" (literally, "within the days of Matsu"), we used to use pine tree branches (the "Matsu" was thought to be a holy tree) to decorate the entrances of houses, companies and public buildings, hoping health, happiness and prosperity. Nowadays, however, I seldom see this kind of decoration in my town, though it may be different from town to town. I regret that many historical customs or traditions have been lost. How about in your countries? Anyhow I hope this year will be fruitful for all of the readers of Kobelco Welding Today.

It is also regretful to me that the supply and demand balance for welding consumables will not noticeably improve due to the shortage of raw materials this year. Even within Kobe Steel, the tight supply of wire rods for welding consumables makes it tough for the company to respond to our increasing demands. As the consumption of welding consumables increases at the sites of most of our customers, we find we cannot fulfill all their demands. Furthermore, our customers experience supply-demand imbalances not only for welding consumables but also for steel plates.

I think these circumstances will continue and even deteriorate further in the near future. What we can do is to do our best to get more raw materials to supply more welding consumables to respond your increasing demands. To ensure better supply of raw materials, we reluctantly have had to accept some price increases. This is another big issue for us. However, I would like everybody to know that although the situation is difficult, I will make my best effort to maximize our supply for your demands. I am also hoping for a slow but certain favorable turn in the market situation in the near future.



Masakazu Tojo
General Manager
International Operations Dept.
Welding Company
Kobe Steel, Ltd.



Canteen in KWE



Kobelco Welding of Europe B.V. (KWE) is situated in the southern part of the Netherlands. At this moment KWE has a total of 42 employees, most of whom are Dutch. During a working-day, there are 3 shifts that make use of the company canteen.

During lunchtime, everybody takes out their own homemade sandwiches, because KWE is too small to have a kitchen that can serve hot meals. However, employees can order sandwiches at a deli-shop. The most popular sandwich is the French bread with vegetables, ham and cheese.

In the canteen are two cold drink machines, one candy machine and one coffee machine. Every morning we receive the newspaper, which is read inside-out by almost everybody.

Reported by
L. Gorissen and T. Bronneberg-Wirtz
KWE

Contents



P1
Products Spotlight:
DWA-55L
for better CTOD

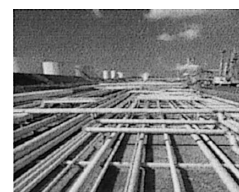

P3-7
Technical Highlight:
GTAW of
stainless steel piping

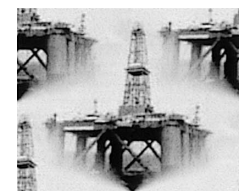

P8
Technical Terms Explanation:
CTOD



P9
Bulletin:
Fighting against...



P10
Bulletin:
Beijing Essen Fair

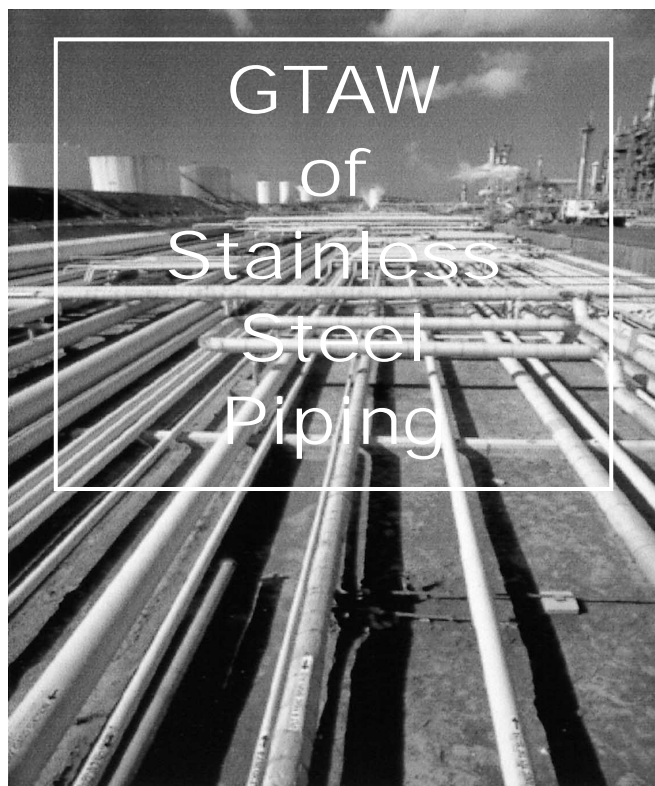

Process piping conveys fluid to and from a plant's various pieces of equipment such as furnaces, reactors, heat exchangers, distillation towers, boilers and turbines. It also connects one process unit with another, and may at times be assembled in long straight runs. Stainless steels - mainly austenitic types - are preferred for piping used at high or cryogenic temperatures, or in highly corrosive environments. The main grades of stainless steels for the process piping are shown in **Table 1**.

Table 1. The main austenitic stainless steel pipes for process piping (ASTM A 312-99)

| ASTM grade | Main chemical composition (%) | | | | | |
|------------|-------------------------------|------------|-----------|-----------|------------|------------|
| | C | Ni | Cr | Mo | Cb+Ta | Ti |
| TP304 | 0.08 max | 8.00-11.00 | 18.0-20.0 | - | - | - |
| TP304L | 0.035 max | 8.00-13.00 | 18.0-20.0 | - | - | - |
| TP310S | 0.08 max | 19.0-22.0 | 24.0-26.0 | - | - | - |
| TP316 | 0.08 max | 11.0-14.0 | 16.0-18.0 | 2.00-3.00 | - | - |
| TP316L | 0.035 max | 10.0-15.0 | 16.0-18.0 | 2.00-3.00 | - | - |
| TP317L | 0.035 max | 11.0-15.0 | 18.0-20.0 | 3.00-4.00 | - | - |
| TP347 | 0.08 max | 9.00-13.0 | 17.0-20.0 | - | 4 x C-0.60 | - |
| TP321 | 0.08 max | 9.00-13.0 | 17.0-20.0 | - | - | 5 x C-0.70 |

Pipe welding procedures

Stainless steel process pipes are usually joined, depending on the diameter and wall thickness, by GTAW for both the root and filler passes, or by GTAW for the root pass and subsequently by shielded metal arc welding (SMAW) or gas metal arc welding (GMAW) for the filler passes. With solid filler rods, the root pass is usually welded from one side using argon gas as back shielding. By contrast, with flux-cored filler rods, the root pass can be completed from one side without back shielding because the flux fuses to become slag, thereby protecting the reverse side bead from the atmosphere. **Table 2** shows a summary of pipe welding procedures used in GTAW, GTAW+SMAW and GTAW+GMAW. KOBELCO GTAW filler rods suitable for welding stainless steels are shown in **Table 3**. This article concentrates on GTAW root-pass welding of pipe joints.

Table 2. A summary of pipe welding procedures by GTAW, GTAW+SMAW and GTAW+GMAW

| Type of filler rod | Root pass | | Filler pass |
|--------------------|-----------|----------------|----------------------------|
| | Process | Back shielding | Process |
| Solid | GTAW | Required | GTAW |
| | GTAW | Required | SMAW, GMAW |
| Flux-cored | GTAW | Not required | GTAW with solid filler rod |
| | GTAW | Not required | SMAW, GMAW |

Table 3. A quick guide to suitable GTAW filler rods for main austenitic stainless steels and dissimilar metals ⁽¹⁾

| ASTM grade | Solid filler rod | | Flux-cored filler rod | |
|----------------------------------|-----------------------------------|-----------------------------|-----------------------|--------------------|
| | Brand | AWS ⁽²⁾ | Brand | AWS ⁽³⁾ |
| TP304 | TGS-308 | ER308 | TGX-308L | R308LT1-5 |
| TP304L | TGS-308L | ER308L | TGX-308L | R308LT1-5 |
| TP310S | TGS-310 | ER310 | - | - |
| TP316 | TGS-316 | ER316 | TGX-316L | R316LT1-5 |
| TP316L | TGS-316L | ER316L | TGX-316L | R316LT1-5 |
| TP317L | TGS-317L | ER317L | - | - |
| TP347 | TGS-347 | ER347 | TGX-347 | R347T1-5 |
| TP321 | TGS-347 | ER347 | TGX-347 | R347T1-5 |
| Dissimilar metals ⁽⁴⁾ | TGS-309 TGS-309L TGS-309MoL | ER309 ER309L ER309LMo | TGX-309L | R309LT1-5 |

Note:
 (1) Available diameters (mm): 1.0, 1.2, 1.6, 2.0, 2.4 and 3.2 for TGS-308, 308L, 309, 309L, 316, 316L and 347; 1.2, 1.6, 2.0, 2.4 and 3.2 for TGS-309MoL; 1.2, 1.6, 2.0 and 2.4 for TGS-317L; 2.2 for TGX series. Spooled filler wires are also available for TGS series for automated GTAW process.
 (2) AWS A5.9-93
 (3) AWS A5.22-95
 (4) Carbon or low alloy steel to austenitic stainless steel dissimilar metal joints

Conventional GTAW root pass welding with solid filler rods

With solid filler rods, back shielding is required in GTAW root pass welding for stainless steel pipes, or the root pass weld cannot penetrate the back side of the joint properly. Poor weld penetration may be caused by oxidation due to the high chromium content of the weld. Therefore, back shielding with an inert gas - commonly argon (Ar) - is a must. Back shielding can be done by locally shielding the weld zone using jigs, or by surrounding the entire piping with shielding gas, as shown in **Figure 1**.

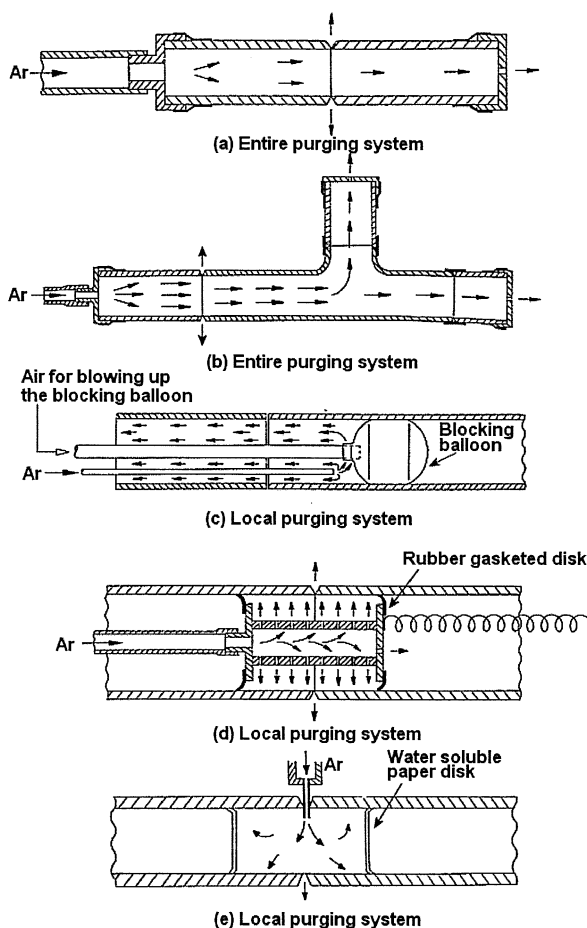

Figure 1. Typical gas purging systems for back shielding the root pass weld in piping

With either technique, a large volume of expensive argon gas and considerable time for setting jigs and purging gas are needed. Moreover, back shielding in this way can be risky because leaks in the gas passage of the system can allow air into the argon gas. Air contamination can cause insufficient fusion and penetration along with oxidized reverse surfaces of the root pass bead. Therefore, care must be taken to ensure back shielding is properly carried out.

Flux-cored filler rods eliminate gas purging through back shielding

To improve traditional GTAW root pass welding, the TGX series of flux-cored stainless steel filler rods have been developed to provide an easy-to-use and economical welding method that produces sound welds without using back shielding.

A TGX filler rod contains a particular flux inside a tubular rod of stainless steel as shown in **Figure 2**. When fused by the arc heat, the flux becomes molten slag. This molten slag can flow smoothly to the reverse side of the root to cover uniformly the penetration bead extruded inside the pipe. This molten slag protects the molten weld metal and red heated bead from the adverse effects of nitrogen and oxygen in the atmosphere. When the weld cools down the slag solidifies to become thin, fragile slag, which can be removed easily by lightly hitting the face of the joint with a chipping hammer. Then a glossy bead will appear on the face and reverse sides of the root with a smooth, uniform ripple without oxidation as shown in **Figure 3**. TGX filler rods provide regular penetration through the entire part of the pipe in all positions as shown in **Figure 4**.

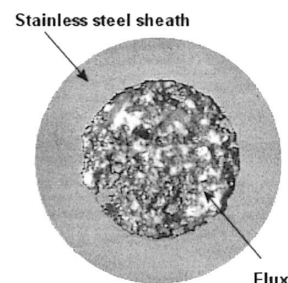

Figure 2. A cross-sectional view of a TGX flux-core filler rod

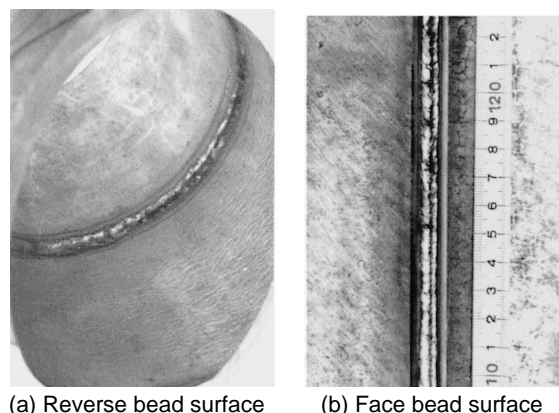

Figure 3. Glossy, regular bead appearance of the root pass weld of a 304-type stainless steel pipe welded with TGX-308L without back shielding

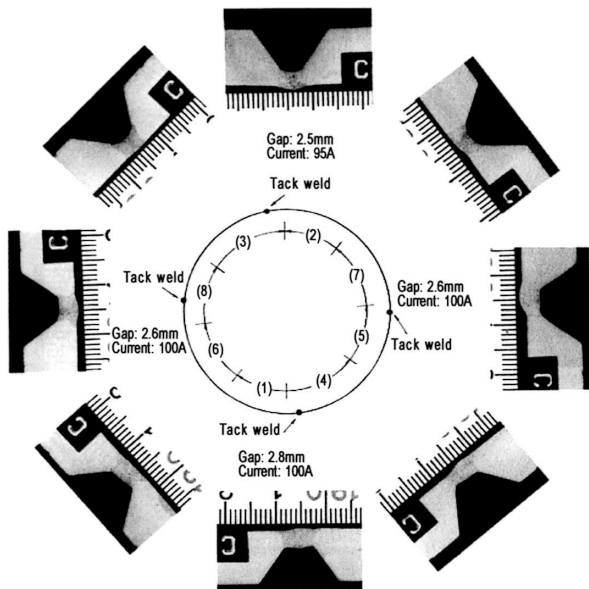

Figure 4. Macrostructure of TGX-308L weld made on a 304-type stainless steel pipe (12 x 150) in horizontally fixed position.

How TGX filler rods can cut costs for gas purging and back shielding

As discussed above, the use of a conventional solid filler rod requires back shielding normally with argon gas. Though the amount of argon gas and time for purging the inside of the pipe vary depending on the inside diameter and the length of the pipe to be purged, they markedly raise the total welding cost. **Table 4** compares how using usual solid filler rods and TGX filler rods affects the factors associated with the costs of root pass welding a pipe with an inside diameter of 305 mm. It is obvious that the using a TGX filler rod can noticeably reduce labor (total work time) by 23-74% because no downtime for setting the back shielding jig and pre-purging is needed. It can also reduce the consumption of shielding gas by 55-91% because no argon gas is needed for pre-purging and back shielding during welding, as compared with a typical solid filler rod.

On the other hand, because a TGX filler rod is a flux-cored rod, both the filler rod and power source consumption will slightly increase during welding because of a slightly lower deposition efficiency (approx. 90%) than with a solid filler rod. Furthermore, the unit price of TGX filler rods is higher than that of solid filler rods. However, calculating the total welding cost by multiplying the unit price of each factor will show that the TGX series filler rods can lead to overall savings.

Table 4. A comparison between TGX and solid filler rods on work time, argon gas consumption, filler rod consumption and power source consumption in root pass welding of a pipe

| Filler rod | TGX filler rod | Solid filler rod | |
|--------------------------------|------------------------|----------------------------|------------------------------|
| Groove preparation | | | |
| Back shielding length of pipe | Without back shielding | 300 mm for local shielding | 6000 mm for entire shielding |
| Pre-purging ⁽¹⁾ | Not required | 5.2 min | 104 min |
| Setting jigs | Not required | 10 min | Not required |
| Welding ⁽²⁾ | 35 min | 30 min | 30 min |
| Arc time rate | 50% | 50% | 50% |
| Total work time | 35 min | 45.2 min | 134 min |
| Total filler rod consumption | 120 g | 100 g | 100 g |
| Pre-purging ⁽¹⁾ | Not required | 122.2 liter | 2444 liter |
| Welding ⁽²⁾ | 263 liter | 225 liter | 225 liter |
| Back shield ⁽³⁾ | Not required | 240 liter | 240 liter |
| Total Ar gas consumption | 263 liter | 587.2 liter | 2909 liter |
| Total power source consumption | 0.405 kwh | 0.358 kwh | 0.358 kwh |

Note:
 (1) The pre-purging condition is per AWS D10.11-7X (Guide for Root Pass Welding and Gas Purging)
 (2) Torch shielding gas flow rate for welding: 15 liter/min
 Welding condition: 110 Amp. x 13 Volt
 (3) Shielding gas flow rate for back shielding: 8 liter/min.

Welding procedure with TGX filler rods

TGX filler rods can be used in almost the same way as solid filler rods. The following are the specific techniques to be used for root pass welding with a TGX filler rod.

- (1) PROPER ROOT OPENING to assure a sound penetration bead.

| Groove preparation | | | |
|---------------------|--------|--------|-----------|
| Plate thickness (T) | 4 mm | 6 mm | 10 mm min |
| Root opening (G) | 2.0 mm | 2.5 mm | 3.0 mm |

- (2) PROPER KEYHOLE TECHNIQUE to help the molten slag flow to the backside of the root.

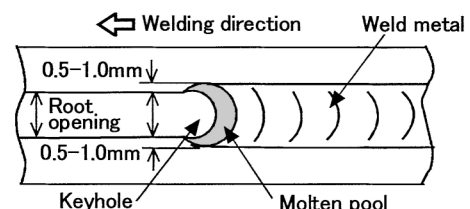

(3) **HIGHER FEEDING PITCH** with careful wire feeding than with a solid filler rod to ensure adequate fusion of the rod and sound penetration beads. This technique is to compensate for the slightly lower deposition efficiency (about 90%) of TGX filler rods.

(4) **PROPER WELDING CURRENT** to ensure regular fusion and penetration.

| | | | |
|-----------------|---------|----------|-----------|
| Plate thickness | 3-5 mm | 6-9 mm | 10 mm min |
| Amperage | 80-90 A | 90-105 A | 90-110 A |

(5) **SHORT ARC LENGTH** to ensure stable crater formation and regular slag flow by keeping the nozzle contact with the groove fusion faces, with a proper extension of tungsten electrode.

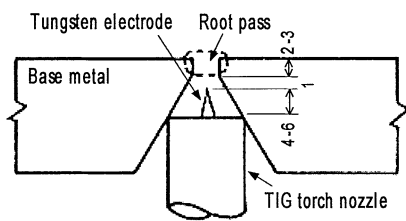

(6) **PROPER CRATER TREATMENT** by turning the crater onto the groove face to prevent crater cracking and shrinkage cavities in the crater.

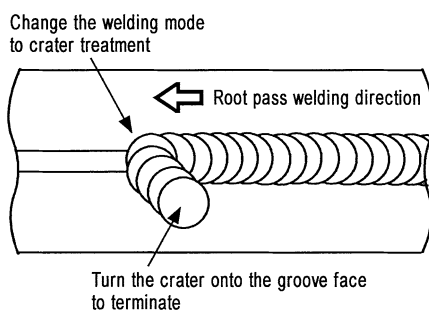

(7) **PROPER BEAD CONNECTION** to prevent oxidation in the penetration bead and to obtain normal penetration bead contour.

Maintain solid slag both on the crater and on the bead on the reverse side when re-starting an arc to join a preceding bead. The re-arcing point should be placed back from the edge of the crater by approximately 10 mm.

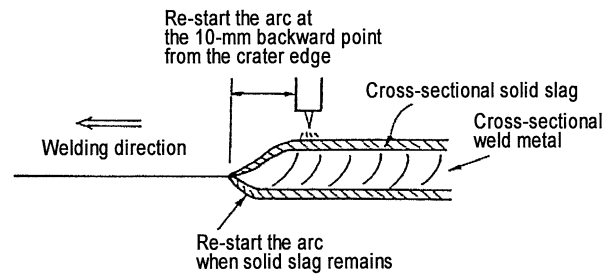

In 5G position welding, the termination of the succeeding bead onto the crater of the preceding bead should be done in the uphill positions to control the molten slag and thereby to help create the keyhole.

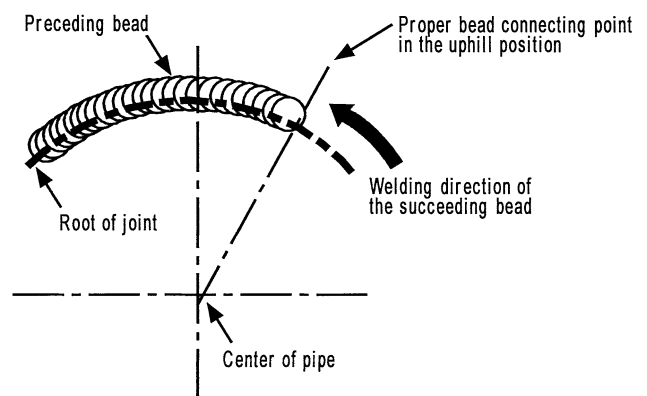

(8) **ONLY ROOT PASS** welding is suitable.

TGX filler rods are designed so that enough slag can be generated to cover both the surfaces of the face and reverse sides of the root pass bead; therefore, if a TGX filler rod is used in filler passes, all of the slag may cover the face side of the bead, thereby causing slag inclusions and lack of fusion.

Chemical, mechanical and microscopic properties of root pass welds

Chemical and mechanical properties of root pass welds are summarized in **Table 5** for individual TGX filler rods. As shown in this table, every TGX filler rod exhibits low nitrogen in the bulk of root pass weld metal. Electron Probe Micro-Analysis (EPMA) of the vicinity of the reverse surface area has verified that no microscopic condensation of nitrogen can be observed. Still more, microstructure testing has revealed that the distribution of ferrite precipitation in the austenite matrix is uniform throughout the root pass weld. Low nitrogen content, together with the glossy bead appearance mentioned above, is evidence of the effectiveness of the shielding effect of the slag of TGX filler rod.

Table 5. Chemical and mechanical properties of single-V groove one-sided weld joints with TGX filler rods for root pass, TGS filler rods and DW flux-cored wires for filler pass

| Filler rod for root pass ⁽¹⁾ | TGX-308L (2.2) | TGX-316L (2.2) | TGX-309L (2.2) | TGX-347 (2.2) | |
|---|--|--|--|---|---------|
| Filler rod and wire for filler pass ⁽²⁾ | TGS-308 (2.4) | TGS-316L (2.4) | DW-309L (1.2) | DW-347 (1.2) | |
| Type of base metal (Thickness, mm) | 304 (9) | 316L (9) | Mild steel / 316 (19) | 321 (20) | |
| Welding position | Flat | Flat | Flat | Flat | |
| Welding current (DCEN for GTAW, DCEP for GMAW) | Root pass: 105A Filler pass: 150-180A | Root pass: 105A Filler pass: 150-180A | Root pass: 105A Filler pass: 180A | Root pass: 105A Filler pass: 180A | |
| Chemical composition and ferrite content of root pass weld metal (%) ⁽³⁾ | C | 0.040 | 0.018 | 0.047 | 0.028 |
| | Si | 0.55 | 0.64 | 0.56 | 0.65 |
| | Mn | 1.11 | 1.48 | 1.36 | 1.78 |
| | Ni | 9.72 | 12.34 | 9.99 | 10.35 |
| | Cr | 18.89 | 18.93 | 19.47 | 18.67 |
| | Mo | - | 2.17 | 0.35 | - |
| | Nb | - | - | - | 0.44 |
| | Ti | - | - | - | 0.07 |
| | N | 0.044 | 0.041 | 0.038 | 0.044 |
| | FS, FN | 4.6-5.7 | 7.1-7.6 | 6.9-8.5 | 4.4-6.2 |
| | SD, F% | 7 | 7.5 | 7 | 6 |
| DD, FN | 5.5 | 8 | 8 | 5 | |
| X-ray test per JIS | 1st grade | 1st grade | 1st grade | 1st grade | |
| Joint tension test (Fracture position) | 593 N/mm ² (Base metal) | 551 N/mm ² (Base metal) | - | 634 N/mm ² (Weld metal) | |
| 2T-radius side and root bend test | No defect | No defect | No defect | No defect | |

Note:
 (1) Torch shielding gas: Ar (without back shielding)
 (2) Torch shielding gas: Ar for GTAW; CO₂ for GMAW
 (3) FS: Ferrite scope; SD: Schaeffler diagram;
 DD: Delong diagram

Corrosion resistance of root pass welds

TGX filler rod root pass beads have to be followed by ordinary GTAW or GMAW filler pass beads to complete the weld joint. Accordingly, the root pass bead is reheated by subsequent beads. The surface of the root pass bead formed by a TGX filler rod without back shielding can therefore become oxidized. By contrast, the root pass bead formed by ordinary solid GTAW with back shielding will not become oxidized if the back shield is maintained until welding of the second or third passes is complete.

The effect of this oxide film on the corrosion resistance of the root pass weld has been examined, using specimens that include the reverse side surfaces affected by the presence or absence of back shielding. The results of a stress corrosion cracking (SCC) test (JIS G 0576: 42% magnesium chloride test), a pitting corrosion test (JIS G 0578: Ferric chloride test) and an intergranular corrosion test (JIS G 0575: Sulphuric acid-copper sulphate) are shown in **Tables 6 thru 8**, respectively.

Table 6. Results of SCC test⁽¹⁾

| Type of base metal | Filler rod | | Ar back shield for root and 2nd pass | Threshold period of macrocrack (h) | |
|--------------------|------------|----------|--------------------------------------|------------------------------------|----------------------|
| | Root pass | 2nd pass | | C-type specimen | L-type specimen |
| 304 | TGS-308L | TGS-308L | Used | 1-2 | 15-20 ⁽²⁾ |
| | TGX-308L | TGS-308L | Not used | 1-2 | 15-20 ⁽²⁾ |
| 304L | TGS-308L | TGS-308L | Used | 1-2 | - |
| | TGX-308L | TGS-308L | Not used | 1-2 | - |

Note:
 (1) Two types of specimens:
 (2) Crack occurred for 1-2 h in the base metal

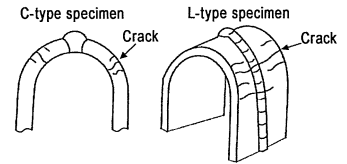

Table 7. Results of pitting corrosion test

| Type of base metal | Filler rod | | Ar back shield for root and 2nd pass | Corrosion weight loss (g/m ² /h) | | |
|--------------------|------------|----------|--------------------------------------|---|-------|-------|
| | Root pass | 2nd pass | | 1 | 2 | Av. |
| 304 | TGS-308L | TGS-308L | Used | 14.77 | 14.12 | 14.45 |
| | TGX-308L | TGS-308L | Not used | 17.67 | 12.61 | 15.14 |
| 316L | TGS-316L | TGS-316L | Used | 5.03 | 3.91 | 4.47 |
| | TGX-316L | TGS-316L | Not used | 4.49 | 5.89 | 5.19 |

Table 8. Results of intergranular corrosion test

| Type of base metal | Filler rod | Ar back shield for root and 2nd pass | Root pass specimen after corrosion and bend test |
|--------------------|---------------------|--------------------------------------|--|
| 304L | Root pass: TGX-308L | Not used | |
| | 2nd pass: TGS-308L | | |
| 316L | Root pass: TGX-316L | Not used | |
| | 2nd pass: TGS-316L | | |

In the SCC test, cracks occurred in the base metal within a short time (1-2 h), whether or not back shielding was present. As for the weld metal, there was no significant difference between TGS and TGX specimens. In the pitting corrosion test, TGS and TGX specimens exhibited almost the same results. In the intergranular corrosion test, TGX specimens showed no intergranular corrosion cracking on either the weld metal or the heat-affected zone of the base metal.

From the above, it can be concluded that, though the reverse surface of TGX root pass beads can become oxidized when welding the subsequent passes without back shielding, its corrosion resistance remains almost the same as that of traditional TGS root pass beads with back shielding.

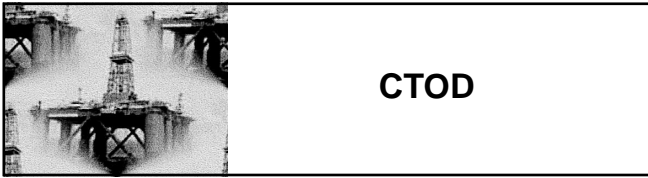

Welded constructions can rapidly fracture in an unstable manner due to welding defects and fatigue cracks occurring in the stress-concentrated areas of a weldment under lower stresses than expected. Unstable fractures or brittle fractures can occur in unexpectedly short periods of time before the end of the designed service life of the structure. This kind of fracture therefore can cause serious damage of a welded construction.

To prevent unstable fractures, the field of fracture mechanics has been established. Investigations into fracture parameters allow a construction's fracture toughness to be estimated in a systematic manner.

The fracture parameters include stress intensity factor (K), J-integral and Crack Tip Opening Displacement (CTOD). Today, CTOD is most widely employed in structural and component design and in assessment of the acceptability of crack extension and allowable applied loads. CTOD testing has been used mainly for carbon-manganese and low alloy steel in the ductile/brittle transition temperature range, and has found much use in weld procedure tests for work on North Sea offshore structures.

CTOD testing has been specified by British Standard (BS 7448-91), Japan Welding Engineering Standard (WES 1108-95) and American ASTM standard (ASTM E1290-93).

Most CTOD tests consist of three-point bending, using a bend specimen of full-thickness that has a notch and a fatigue pre-crack at the tip of the notch. At the initial stage of loading the specimen, the plastic deformation occurs at the original fatigue crack tip, causing a certain amount of opening displacement at the tip of the crack in the period from δ_c to δ_u - **Figure 1**.

The fracture pattern of the specimen is analyzed and identified according to the following descriptions; that is, from completely brittle fracture to fully plastic collapse.

- (1) A brittle fracture (either unstable cracking or pop-in in the load-displacement record) occurring at the initial stage of loading; the CTOD value is designated δ_c .
- (2) A brittle fracture occurring following slow (ductile) crack growth; the CTOD value is designated δ_u .
- (3) A slow (ductile) crack growing to fracture the specimen at the maximum load under conditions of stable crack growth; the CTOD value is designated δ_m .

The CTOD value is determined as the opening displacement (mm) measured with a clip gauge at the tip of the original fatigue crack when the brittle fracture of (1) or (2) above occurs, or when the maximum load has been first attained under the condition of (3). That is, the CTOD value of a particular structure shows the degree to which the structure is durable under applied loads when it contains a crack that can be detected by nondestructive testing. With a larger CTOD value, the structure can accommodate a longer crack or larger loads.

The CTOD value can be affected by temperature and material thickness; thus, the requirement for CTOD is determined according to the service temperature and the maximum wall thickness of the relevant structure; e.g. CTOD at $-10 \geq 0.25$ mm for offshore structures. With the recent trends of ever larger welded constructions and of operating in ever more severe environments at freezing cold seas, the requirements have tended to become stringent.

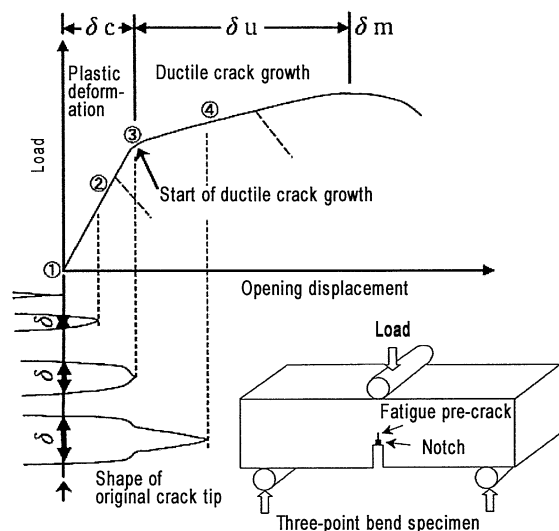

Figure 1. Growth of original fatigue crack and load-displacement transition with a three-point bend specimen

(Reference: Kobe Steel's Technical Guide, No. 395, 2003)

Fighting against extreme climate

A happy new year to dear readers of Kobelco Welding Today! I am greeting you from China. Tangshan City, Hebei Province, where I am working, is situated in a position to form a triangle with the two nearby cities of Beijing and Tienchin.

Here in Tangshan winter comes immediately after summer, and while the highest temperature in summer reaches 40 , the winter lows sink to - 20 ! With such an extreme temperature difference, maintaining good health is very difficult and you can never avoid catching a cold at least once.

Yet, we, the members of the Sales Department, are briskly developing our activities, supported by our customers, and crisscrossing this vast land of China in all weather, fair or foul, windy or calm, or scorching or freezing. For, we are a quite young company that reached its first anniversary only last November, and that is full of the most youthful energy among other companies in the Kobelco Group.

We are determined to continue our strenuous efforts, planning to run north to instruct on how to adjust welding conditions, south to speak for high efficiency achieved by our products, east to hold a training course on welding skill and west to observe actual production welding by DREAM-KOBELCO, our sales car shown in the photo.

Last but not least, may the year 2005 be a splendid year for you all and for us!

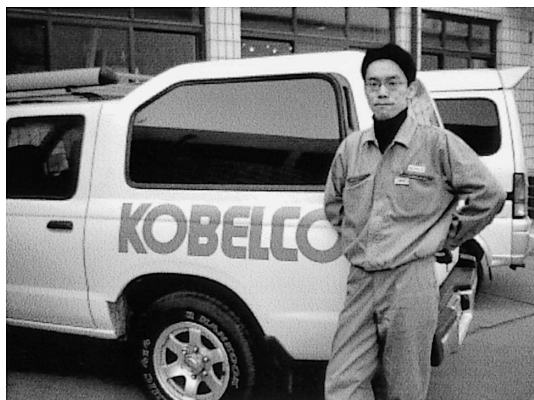

The reporter with a reliable partner,
DREAM KOBELCO

Reported by Daisuke HINO
Sales Dept., Kobe Welding Tangshan

Greetings from KWAI



Kazuhiko Ito
Kobelco Welding of America

I feel most honored to have a chance to introduce myself to readers of Kobelco Welding Today. Kazuhiko Ito is my name, but my coworkers at Kobleco Welding of America (KWAI) have given me the nickname, " Kevin. "

I am now engaged as an engineer in the North American and Mexican markets, where I support customer inquiries on welding technology or techniques directly at their fabrication sites.

Prior to coming to Houston, USA last April, I had been working in the design of flux-cored wires for mild steel since I joined the Welding Company of Kobe Steel. Using the experience I have gained in my career, I will do my best to provide our customers with effective technical services so that they will get the best out of our products.

KWAI will have its 15th birthday in 2005. On this occasion we, KWAI, pledge to be your most reliable partner, following the " QTQ " business slogan - Quality Products, Technical Support and Quick Delivery.

Finally, " Kevin " is wishing that his stay in USA will be wonderful and unforgettable years of experience, not only in business but also in " Kevin s " life with many of you.



BEIJING ESSEN WELDING

Beijing Essen, one of the biggest international welding and cutting fairs in Asia has now established itself as an annual event. Following last year's show, this year it was held for four days from November 10 through 13, in the 2nd through the 8th Halls of the China International Exhibition Center in Beijing. There were 1,745 booths, covering an area of 30,000 m².

Kobe Steel took part in the fair jointly with Kobe Welding of Tangshan (KWT) as members of the



The KOBELCO Group booth attracts many visitors from the Chinese and overseas markets at Beijing Essen Fair

Tangshan Exhibitors Group. On display were such products as Cr-Mo steel welding consumables (used widely in the energy-related fields that have led the boom in the Chinese Market), hard-surfacing welding strips, and CO₂ solid wires manufactured by KWT. Our booth drew many visitors.

On November 10 and 12, Mr. Maruyama, General Manager of the Shinko-Taseto Research and

Development Center, gave a lecture on welding of low-alloy Cr-Mo steel, stainless steel and dissimilar metals. Over 30 people attended the lecture on both days and the question-and-answer sessions were so active that there was a request to hold a similar lecture next year, too.



Eager business talks between visitors and the exhibitor

The lecturer and collaborators pose after successful welding seminar

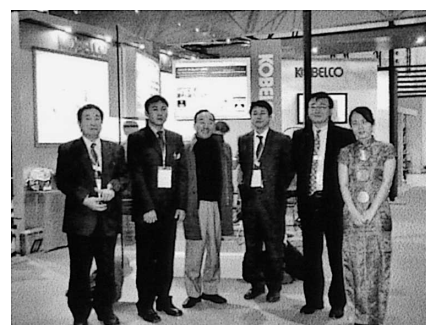

More than 500 domestic and overseas exhibitors participated in the fair. There were 13,863 Chinese visitors and 863 from abroad; 53,013 attended cumulatively over four days. The number of visitors, the exhibition area and the number of exhibitors all exceeded those of last year's Shanghai International Welding Fair. Further increasing the pride of the fair promoter was that this was the 2nd biggest welding fair in the world. It also symbolized the dynamism of the expanding Chinese Market and the energy of the exhibitors, who are all fighting for dominance in the market.

Reported by Y. Muraoka
IOD, Kobe Steel

KOBELCO WELDING TODAY

January 2005, Vol.8 (No.1)

Publisher : The International Operations Dept., Welding Company, Kobe Steel, Ltd.

Printer : Fukuda Printing Co., Ltd.

Editor : KOBELCO WELDING TODAY Editorial Staff

URL : <http://www.kobelco.co.jp>

E-MAIL : iod@melts.kobelco.co.jp

WELDING CONSUMABLE

KOBELCO

THE WORLDWIDE MANUFACTURER

THE
KOBELCO
GUARANTEE:

QTA

QUALITY PRODUCTS
TECHNICAL SUPPORT
QUICK DELIVERY



International slogan of Kobelco Welding Group

GLOBAL MANUFACTURING AND SALES BASES

JAPAN :

KOBE STEEL, LTD. Welding Company
International Operations Dept.
9-12, Kita-Shinagawa 5-chome, Shinagawa-ku,
TOKYO, 141-8688

JAPAN

Tel. (81)3 5739-6331 Fax. (81)3 5739-6960

EUROPE :

KOBELCO WELDING OF EUROPE B.V.
Eisterweg 8, 6422 PN, Heerlen, The Netherlands
Tel. (31)45-547-1111 Fax. (31)45-547-1100

USA :

KOBELCO WELDING OF AMERICA INC.
HOUSTON HEAD OFFICE
4755 ALPINE, SUITE, 250, STAFFORD, TEXAS 77477 USA
Tel. (1) 281 240-5600 Fax. (1) 281 240-5625

KOREA :

KOBE WELDING OF KOREA CO., LTD.
21-14, Palryong-Dong, Changwon, Kyongnam, Republic of
Korea
Tel. (82)55 292-6886 Fax. (82)55 292-7786

CHINA :

KOBE WELDING OF TANGSHAN CO., LTD.
196, HUOJU ROAD, TANGSHAN, NEW & HI-TECH
DEVELOPMENT ZONE, TANGSHAN, HEBEI, P.R. CHINA, 063020
Tel. (86)315 385-2806 Fax. (86)315 385-2829

SINGAPORE :

KOBE WELDING (SINGAPORE) PTE. LTD.
20, Pandan Avenue, Jurong, Singapore 609387, Republic of
Singapore
Tel. (65)6268 2711 Fax. (65)6264 1751

THAILAND :

THAI-KOBE WELDING CO., LTD.
500, Soi 1, Bangpoo Industrial Estate, Sukhumvit Road,
Praeksa, Samutprakarn 10280, Thailand
Tel. (66)2 324-05 88 - 91 Fax. (66)2 324-07 97

KOBE MIG WIRE (THAILAND) CO., LTD.

491, Soi 1, Bangpoo Industrial Estate, Sukhumvit Road,
Praeksa Samutprakarn 10280, Thailand
Tel. (66)2 324-05 88 - 91 Fax. (66)2 324-07 97

MALAYSIA :

ST KOBE WELDING (MALAYSIA) SDN. BHD.
Plot 502, Jalan Perusahaan Baru, Kawasan Perusahaan
Prai, 13600 Prai, Malaysia
Tel. (60)4-3905792 Fax. (60)4-3905827

INDONESIA :

P.T. INTAN PERTIWI INDUSTRI
(Technically-Collaborated Company)
Jalan P Jayakarta 45, Block A/27,
Jakarta 11110, Indonesia
Tel. (62)21-639-2608 Fax. (62)21-649-6081

KOBELCO WELDING TODAY