

KOBELCO WELDING TODAY

2013
Special
Edition

**KOBELCO WELDING CONSUMABLES FOR
LOW-TEMPERATURE STEEL**



KOBELCO

A Quick Guide to Suitable Welding Consumables

■ For FCAW and GMAW

Ar-20%CO₂

TS (MPa) min.		490	520	550	610	670	770
YS (MPa) min.		350	400	420	500	550	690
IV (J) min.		35	40	42	50	55	69
Service temperature (°C)	-20	DW-A50 MG-S50 (SR)	DW-A81Ni1 MG-T1NS		DW-A65L MG-T1NS	MG-S70	MG-S80
	-30	DW-A55E DW-A55ESR (SR)					
	-40					DW-A80L	DW-A80L
	-50	DW-A55L MX-A55Ni1 MX-A55T MG-S50LT (SR)	DW-A55L DW-A55LSR (SR)	DW-A81Ni1	DW-A62L MG-S62L	MX-A80L MG-S88A	MX-A80L MG-S88A
	-60		MX-A55Ni1 MX-A55T MG-S50LT	DW-A55L DW-A55LSR MX-A55Ni1 MX-A55T			

100%CO₂

TS (MPa) min.		490	520	550	610
YS (MPa) min.		350	400	420	500
IV (J) min.		35	40	42	50
Service temperature (°C)	-20	DW-50	DW-55L		DW-62L
	-40	DW-55E			
	-50	DW-50LSR (SR)	DW-55LSR (SR)	DW-55LSR	
	-60	DW-55L			

MG-····Solid Wire
MX-····Metal-cored Wire

Tips for successful welding results

1. This guidance is to help users select appropriate welding consumables. Users are requested to confirm whether the selected brand (Trademark + Trade designation) can satisfy the job specifications including ship-class approvals and other specific requirements before use. The Charpy impact energies are based on the requirements for offshore structures, which may be stricter than for other common low-temperature applications. The Charpy impact absorbed energies are the average of three testing specimens. Yield strength includes yield point and 0.2% offset strength.
2. Mechanical properties of weld metal may adversely be affected by postweld heat treatment (PWHT). Therefore, the trade designations having no designation of "SR" in the parentheses are recommended to use in the as-welded condition, whereas the brands having the SR designation can be used in the PWHT condition as well as in the as-welded condition.
3. A change of polarity may affect the usability of welding consumables, and the chemical composition and mechanical properties of weld metals; therefore, use the polarity as indicated in the parentheses.

■ For SMAW

DCEP

TS (MPa) min.	490	520	550	610	670	770
YS (MPa) min.	350	400	420	500	550	690
IV (J) min.	35	40	42	50	55	69
Service temperature (°C)	-20	LB-52 (SR) LB-52-18	LB-57	LB-62UL LB-62 (SR) LB-62U (SR)		LB-106
	-40	LB-52U LB-7018-1	NB-1SJ (SR)	LB-62L (SR) LB-55NS (SR)	LB-65L (SR) LB-67L (SR) LB-67LJ	LB-70L
	-60	NB-1SJ (SR) LB-52NS (SR) LB-52NSU (SR)				—

AC

TS (MPa) min.	490	520	550	610	670	770
YS (MPa) min.	350	400	420	500	550	690
IV (J) min.	35	40	42	50	55	69
Service temperature (°C)	-20	LB-52 (SR) LB-52-18	LB-57 (SR)	LB-62UL LB-62 (SR) LB-62U (SR)		LB-106
	-40	LB-52U (SR)	NB-1SJ (SR) LB-52NS LB-52NSU (SR)	NB-1SJ (SR) LB-62L (SR)	LB-62L (SR)	LB-Y75
	-60	NB-1SJ (SR) LB-52NS (SR) LB-52NSU (SR)				

LB-52U }
LB-52NSU } for Uranami welding
LB-62U }



■ For SAW

DCEP

TS (MPa) min.	490	520	550	610	670	770	
YS (MPa) min.	350	400	420	500	550	690	
IV (J) min.	35	40	42	50	55	69	
Service temperature (°C)	-20	PF-H55AS / US-36J (SR)	PF-H55AS / US-36J PF-H58AS / US-36J	PF-H80AK / US-56B		PF-H80AS / US-255	PF-H80AS / US-80LT
	-40			—	PF-H62AS / US-2N		
	-60					—	

AC

TS (MPa) min.	490	520	550	610	670	770	
YS (MPa) min.	350	400	420	500	550	690	
IV (J) min.	35	40	42	50	55	69	
Service temperature (°C)	-20	MF-38 / US-36 (SR)	MF-38 / US-49A (SR)		MF-38 / US-40	PF-H80AK / US-255	PF-H80AK / US-80LT
	-40	PF-H55LT / US-36 (SR)	PF-H55S / US-49A (SR)		PF-H55S / US-40 PF-H80AK / US-56B		
	-60		PF-H55LT / US-36 PF-H55LT / US-36J (SR)	PF-H55LT / US-36J	PF-H80AK / US-56B PF-H55S / US-2N (SR)		

- MF-38 : Fused type flux
- PF-H... : Bonded type flux

■ For GTAW

TS (MPa) min.	490	520	550	610	670	770
YS (MPa) min.	350	400	420	500	550	690
IV (J) min.	35	40	42	50	55	69
Service temp. (°C)	-20	TG-S50 (SR) TG-S51T (SR)	TG-S62 (SR)			TG-S80AM (SR)
	-30					
	-40	TG-S1MT TG-S1N	TG-S60A (SR)			
	-60					

Table 1: Typical welding consumables for low temperature services (As welded condition)

Welding process	Shielding gas or polarity	Welding consumables	AWS Classification	Min. applicable strength (MPa)	Applicable temperature(°C)		Chemical compositions of weld metal (mass %)						
					vE \geq 47J, $\delta\geq$ 0.25mm or \geq 0.10mm*1		C	Si	Mn	Ni	Mo	Ti	B
					vE	CTOD (δ)							
GMAW (Solid)		MG-S50LT	A5.18 ER70S-G	400/520	-60	-30	0.07	0.2	1.4	-	-	0.02	0.003
		MG-T1NS	A5.28 ER80S-G	500/610	-40	-	0.06	0.3	1.4	1.1	0.3	-	-
		MG-S62L	A5.28 ER90S-G	500/610	-60	-	0.07	0.3	1.4	1.9	-	0.02	0.003
		MG-S88A	A5.28 ER120S-G	690/770	-60	-	0.07	0.3	1.2	3.4	0.8	-	-
GMAW (FCW)	80%Ar-20%CO ₂	DW-A55ESR	A5.20 E71T-12M-J	400/490	-40	-	0.05	0.5	1.4	0.4	-	0.05	0.003
		MX-A55Ni1	A5.28 E80C-G	400/520	-60	-	0.05	0.3	1.7	0.9	-	-	-
		MX-A55T	A5.28 E80C-G	400/520	-60	-	0.05	0.3	1.4	1.4	-	-	-
		DW-A81Ni1	A5.29 E81T1-Ni1M-J	420/550	-60	-	0.05	0.3	1.3	0.9	-	0.04	0.005
		DW-A55LSR	A5.29 E81T1-Ni1M	420/550	-60	-20	0.05	0.3	1.3	0.9	-	0.04	0.003
		DW-A55L	A5.29 E81T1-K2M	460/550	-60	-20	0.06	0.3	1.2	1.4	-	0.06	0.003
		DW-A62L	A5.29 E91T1-GM	500/610	-60	-40 *1	0.07	0.3	1.3	2.1	-	0.04	0.003
		DW-A65L	A5.29 E91T1-K2M-J	550/620	-60	-	0.05	0.3	1.2	1.8	0.1	0.04	0.003
		DW-A80L	A5.29 E111T1-GM-H4	690/770	-40	-	0.07	0.3	1.9	2.5	0.2	0.07	-
		MX-A80L	A5.28 E110C-G H4	690/770	-60	-	0.06	0.5	1.9	2.4	0.1	-	-
	CO ₂	DW-50LSR	A5.29 E71T1-GC	400/490	-50	-10	0.07	0.3	1.3	0.9	-	0.06	0.04
		DW-55L	A5.29 E81T1-K2C	400/520	-60	0	0.04	0.4	1.3	1.4	-	0.05	0.003
		DW-55LSR	A5.29 E81T1-K2C	420/550	-60	-10	0.06	0.3	1.2	1.5	-	0.05	0.004
		DW-62L	A5.29 E91T1-Ni2C-J	500/610	-60	-40 *1	0.08	0.3	1.3	2.6	-	0.06	0.004
SMAW	DCEP /AC	LB-7018-1	A5.1 E7018-1	400/490	-40	0	0.06	0.4	1.5	-	-	0.03	0.004
		LB-52U	A5.1 E7016	400/490	-40	-	0.06	0.5	1.0	-	-	-	-
		LB-52NSU	A5.5 E7016-G	400/490	-60	-	0.06	0.6	1.3	0.5	-	0.02	0.003
		LB-52NS	A5.5 E7016-G	400/490	-60	-30	0.08	0.4	1.4	0.5	-	0.02	0.002
		LB-55NS	A5.5 E8016-G	420/550	-60	-10	0.06	0.3	1.5	0.9	0.1	0.01	0.003
		NB-1SJ	A5.5 E8016-G	420/550	-60	-40	0.08	0.3	1.3	1.3	-	0.02	0.002
	DCEP	LB-62L	A5.5 E8016-C1	500/610	-60	-10	0.07	0.3	1.0	2.1	0.1	0.02	0.002
		LB-67L	A5.5 E9016-G	500/610	-60	-20	0.06	0.3	1.1	2.6	-	0.01	0.002
		LB-67LJ	A5.5 E9016-G	500/610	-60	-40 *1	0.07	0.4	1.1	2.6	-	0.02	0.002
		LB-70L	A5.5 E10016-G	620/720	-40	-	0.03	0.4	1.1	3.5	0.4	Cr: 0.2	-
		LB-80L	A5.5 E11018-G H4	690/770	-60	-	0.04	0.6	1.4	2.9	0.7	-	-
		AC	LB-Y75	A5.5 E10016-G	620/720	-60	-	0.05	0.4	1.2	3.6	0.4	Cr: 0.2
SAW	DCEP	PF-H55AS/US-36J	A5.17 F7A8-EH14 F7P8-EH14	400/520	-60	-20	0.07	0.2	1.4	-	-	0.02	0.004
		PF-H58AS/US-36J	A5.17 F7A8-EH14 F7P8-EH14	420/530	-60	-20	0.07	0.2	1.4	-	-	0.02	0.004
		PF-H62AS/US-2N	A5.23 F9A8-EG-Ni2 F9P8-EG-Ni2	500/610	-60	-20	0.05	0.3	1.3	2.5	0.2	0.01	-
		PF-H80AS/US-80LT	A5.23 F11A10-EG-G	690/770	-60	-	0.06	0.5	1.6	2.4	0.7	-	-
	AC	PF-H55LT/US-36	A5.17 F7A8-EH14 F7P8-EH14	400/520	-60	-50	0.08	0.2	1.4	-	-	0.02	0.004
		PF-H55LT/US-36J	A5.23 F8A8-EG-G	420/550	-60	-20	0.09	0.3	1.7	-	-	0.02	0.004
		PF-H55S/US-2N	A5.23 F9A10-EG-Ni2 F9P8-EG-Ni2	500/610	-60	-20	0.08	0.3	1.3	2.3	0.2	-	-
		PF-H80AK/US-255	A5.23 F10A8-EG-G F9P6-EG-G	620/720	-60	-	0.06	0.3	1.5	2.2	0.5	-	-
	PF-H80AK/US-80LT	A5.23 F12A10-EG-G	690/770	-60	-	0.08	0.3	1.7	2.5	0.7	-	-	
GTAW	DCEN	TG-S1N	A5.28 ER70S-G	400/490	-60	-	0.05	0.3	1.1	0.8	0.1	-	-
		TG-S60A	A5.28 ER80S-G	500/620	-60	-	0.06	0.1	1.2	0.9	0.6	-	-
		TG-S80AM	A5.28 ER110S-G	690/770	-60	-	0.06	0.1	1.2	2.8	0.7	Cr: 0.4	-

Note: *1: CTOD value at -40°C is \geq 0.10mm.

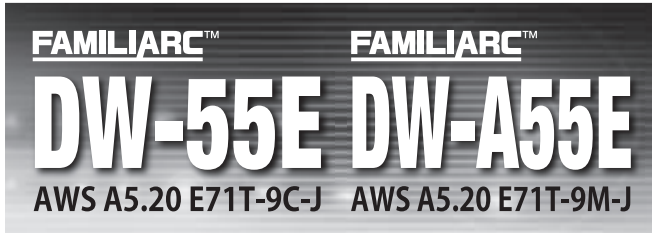

Excellent low-temperature notch toughness at down to -40°C enables DW-55E and DW-A55E to be more versatile in application. Offshore structures and ships are typical applications for these all-position rutile-cored wires.



Offshore structures require strict notch toughness in order to endure operations in harsh weather and roaring waves.

DW-55E and DW-A55E are more than equal to conventional wires

DW-55E and DW-A55E are classified as E71T-9C-J and E71T-9M-J, respectively. The last digit, J, of the AWS classification designates these wires as meeting the optional requirements for improved toughness with 27J at -40°C . Conventional E71T-9C and E71T-9M wires meet only the requirement of 27J at -30°C . The digits C and M are given for wires suitable for CO_2 and Ar- CO_2 shielding, respectively.

Beyond the matter of the AWS classification, the excellent notch toughness of DW-55E and DW-A55E have been proven in production weld joints. Table 1 shows impact test results of the weld metals of these wires welded with butt joints in several welding positions. As shown in the table, the results are sufficiently high.

Table 1: Charpy impact absorbed energies (J) of as-welded DW-55E and DW-A55E weld metals (2mm-V side notch)

Trade desig. (Shielding gas)	Welding position (AV. heat input)	Testing temperature ($^{\circ}\text{C}$)	
		-40	-20
DW-55E (100% CO_2)	Flat (1.8 kJ/mm)	103, 116, 95 (Av. 105)	143, 160, 100 (Av. 134)
	Vertical (2.2 kJ/mm)	110, 90, 95 (Av. 98)	126, 124, 120 (Av. 123)
DW-A55E (80%Ar-20% CO_2)	Flat (1.7 kJ/mm)	86, 75, 81 (Av. 80)	118, 123, 118 (Av. 119)
	Vertical (2.4 kJ/mm)	73, 69, 75 (Av. 72)	98, 87, 90 (Av. 92)

Ship-class approvals certify the quality of DW-55E and DW-A55E for high grade steels in shipbuilding

DW-55E and DW-A55E are approved as high-grade flux-cored wires by the ship classification societies as shown in Table 2.

Table 2: Ship-class approvals

Ship class	DW-55E	DW-A55E
ABS	3YSA, 3Y400SA(H5)	4Y400SA(H5)
LR	4Y40S(H5)	4Y40S(H5)
DNV	III YMS(H5)	-
BV	SA3, SA3YM(H5)	SA3YM(H5)
NK	KSW54Y40G(C)H5	-
Others	GL, CR	GL

- ABS: American Bureau of Shipping (USA)
- LR: Lloyd's Register of Shipping (UK)
- DNV: Det Norske Veritas (Norway)
- BV: Bureau Veritas (France)
- NK: Nippon Kaiji Kyokai (Japan)
- GL: Germanischer Lloyd (Germany)
- CR: Central Research of Ships S. A. (Taiwan)

Grade-3 and Grade-4 approvals are given to the welding consumables that satisfy the strict notch toughness specified by the ship class rules to ensure the suitability of the welding consumables for the extra-high notch toughness steels classified as E-grade of mild steel and EH-grade of high strength steel (e.g. EH 32 and EH 36). E- and EH-grade steels are used for the more important parts of a ship's hull, such as stress-concentrating corners, to ensure the resistance of the hull against brittle fracture during a rough voyage.

The use of proper amperage and voltage is essential

DW-55E and DW-A55E offer glossy bead appearance with fine ripples, negligible spatter losses and self-peeling slag removal in uses over a broad range of welding amperage and arc voltage as shown in Figure 1 in all-position welding with single pass and multiple passes.

Figure 1: Proper ranges of welding ampere and arc voltage with DW-55E (1.2, 1.4 and 1.6 mmφ) and DW-A55E (1.2 and 1.6 mmφ).

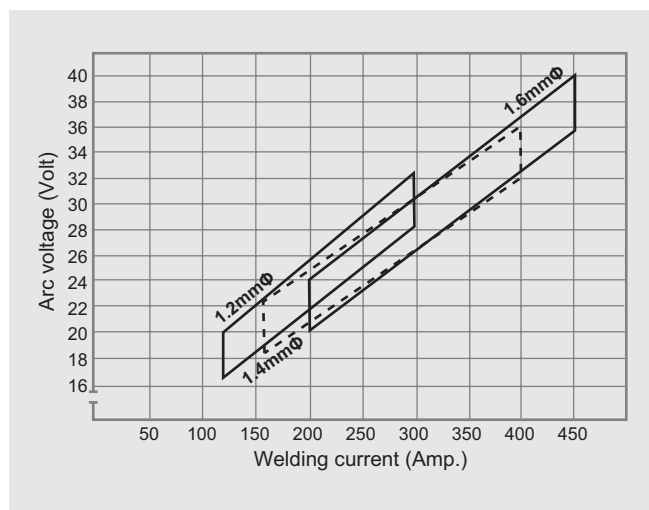

Heat input is a key factor in quality control of welds

Heat input is a predominant factor particularly for controlling the impact toughness of welds. Heat input can be given by the following formula:

$$HI = A \times V \times 60 / S \text{ (kJ/mm)}$$

where *A* is for welding current (ampere), *V* is for arc voltage (volt), and *S* is for travel speed (mm/min).

Table 2 shows recommended heat input for DW-55E and DW-A55E in all-position welding. The minimum heat input is to control hardness (Hv: 280 max) of the weld metal, while the maximum heat input is to ensure

Table 2: Recommended heat input ranges for DW-55E and DW-A55E flux-cored wires

Welding position	Heat input (kJ/mm)
1F, 1G	1.0-3.0
2F	1.0-2.0
2G	1.0-1.5
3F, 3G, 4F	1.5-3.0

1F: flat fillet; 1G: flat groove; 2F: horizontal fillet;
2G: horizontal groove; 3F: vertical fillet;
3G: vertical groove; 4F: overhead fillet

the impact notch toughness of the weld metal.

Travel speeds determine fillet leg lengths

In quality control of fillet welds, control of leg length is essential, provided the fillet weld has no excessive concavity. Figure 2 shows how travel speed determines the leg length of fillet welds in uses of DW-55E and DW-A55E.

Figure 2: Fillet leg length vs. travel speed in uses of DW-55E and DW-A55E in single pass horizontal fillet welding.

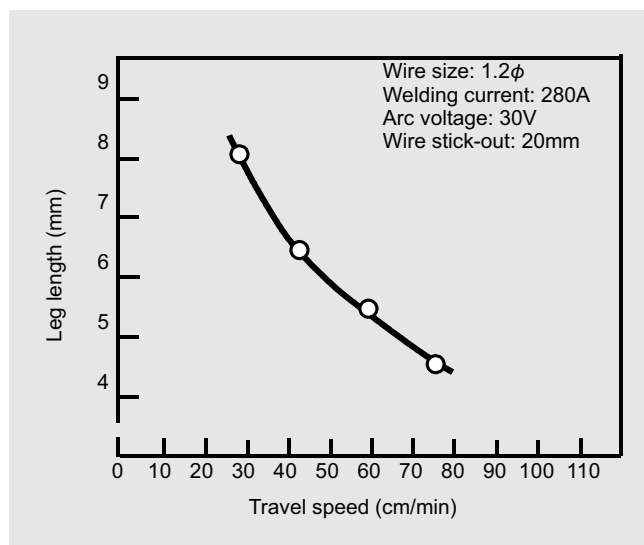

Low ambient temperatures and thick base metals require preheating

Mild steel and 490MPa-class high strength steel have quite good weldability due to low carbon equivalent and low impurities, and DW-55E and DW-A55E weld metals contain diffusible hydrogen as low as Grade H5 of the ship class requirement (0.05 ml/g max). Therefore, the welding of such materials can generally be conducted successfully. However, cold cracking can occur in the welds when the ambient temperature is low and the base metal is thick – thus the welding joint is apt to be greatly restrained, thereby causing stress concentration in the weld. In such cases, preheating the base metal by 30-150°C (the exact temperature depends on the metal temperature and plate thickness) is recommended in order to prevent cold cracking in the welds. Where the surrounding temperature exceeds 5°C and plate thickness is 25 mm or less, no preheating is needed.

TRUSTARC™ DW-55L **TRUSTARC™ DW-A55L**
AWS A5.29 E81T1-K2C **AWS A5.29 E81T1-K2M**

With superior notch toughness at low temperatures down to -60°C and higher tensile strength, DW-55L and DW-A55L surpass DW-55E and DW-A55E, respectively, featuring excellent usability. Offshore structures in cold districts, and LNG and LPG carriers are typical applications for these rutile-base flux-cored wires using CO_2 or Ar-CO_2 shielding.



In construction of LPG ships, low-temperature impact energy of welds is strictly controlled in order to assure the fracture resistance in low-temperature services

DW-55L and DW-A55L offer unsurpassed low-temperature notch toughness over conventional wires

With the sophisticated design of the chemical composition (containing 1.5%Ni), DW-55L (for CO_2 shielding) and DW-A55L (for Ar-CO_2 shielding) produce weld metals of high impact energy surpassing the usual E81T1-K2C and E81T1-K2M classes of flux-cored wires. These AWS classes require 27J at -29°C ; however, the KOBELCO brands can assure the required value at lower temperatures down to -60°C .

Figures 1 and 2 show test results of weld metal impact energy of DW-55L and DW-A55L, respectively. Because the test specimens were removed from the varied locations in the weld metal, impact energies are scattered a little due to a variety of microstructures caused by different heat input and pass sequences. However, they maintain adequate levels of impact energy, meeting the grade-5 ship class requirements of Lloyd's Register of Shipping (LR) and Det Norske Veritas (DNV) (47J in flat welding and 41J in vertical welding at -60°C).

Figure 1: Charpy impact test results of DW-55L multiple-pass weld metal in the following conditions. Each plot shows the average of three values. (Base metal: BS 4360-50D; Heat input: Av. 1.8 kJ/mm (Flat), Av. 2.5 kJ/mm (Vertical), and Av. 1.1 kJ/mm (Horizontal); Wire size: 1.2 mm ϕ ; Preheat: 100°C ; Interpass temperature: $100-150^{\circ}\text{C}$; Shielding gas: CO_2)

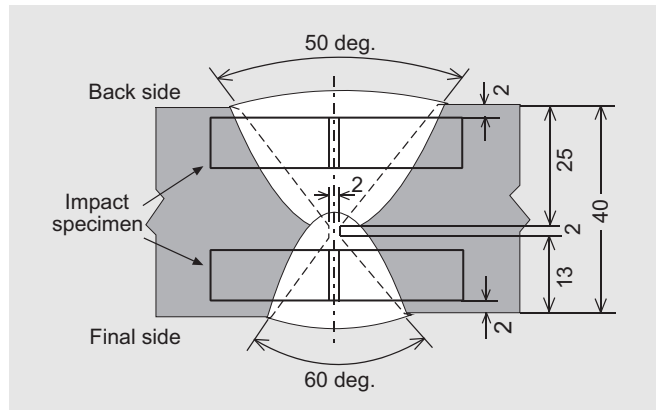
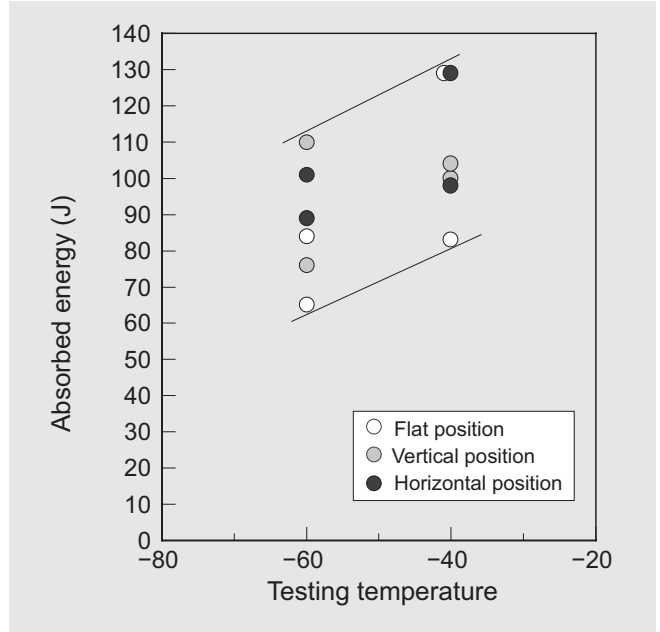
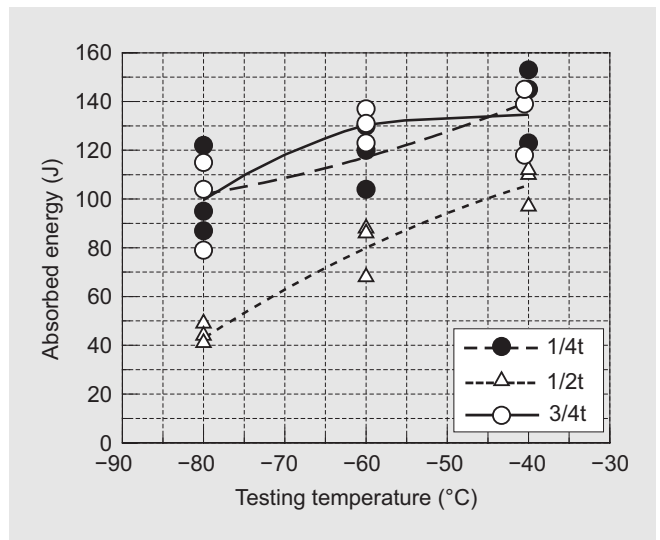

Figure 2: Charpy impact toughness of DW-A55L weld metal (60mm base metal; Double bevel groove; 80%Ar-20% CO_2 ; Vertical welding; Av. 1.8kJ/mm heat input).



CTOD data provide critical engineering assessment of the quality of DW-55L and DW-A55L

The most common method of measuring the fracture toughness (resistance to extension of a crack) of welded joints is the Charpy V-notch test. In addition to this, other types of tests are specified, depending on the strictness required, for an engineering critical assessment. The crack tip opening displacement (CTOD) test is one of them. The CTOD requirement for welds depends on design temperature, operational strictness, plate thickness, and postweld heat treatment of the components. As shown in Table 1, both wires display sufficient CTOD values at low temperatures.

Table 1: Typical CTOD test results of DW-55L and DW-A55L weld metals in vertical welding (as-welded)

Trade desig. (Shielding gas)	Test plate (Heat input)	Testing temp. (°C)	CTOD ⁽¹⁾ (mm)
DW-55L (100%CO ₂)	BS4360 Gr. 50D, 40 mmt (Av. 2.5 kJ/mm)	-10	1.68
			2.05
			1.55
DW-A55L (80%Ar-20%CO ₂)	JIS G 3106 SM490A, 60 mmt (Av. 1.8kJ/mm)	-36	0.43
			0.88
		-40	0.37
			0.38
			0.79

(1) CTOD test method: BS5762-79 for DW-55L; BS7448-91 (W=B) for DW-A55L

High deposition rate and wide A-V range are essential factors of high efficient welding

Figure 3 shows deposition rates of DW-55L and DW-A55L with diameters of 1.2 and 1.4 mm ϕ , which are higher than those of solid wires by approximately 5-10% and those of covered electrodes by approximately 65-85%. With a higher deposition rate, the total arc time can be decreased in welding a particular mass of welding grooves and, in turn, welding can be carried out more efficiently.

For efficient welding, it is essential to optimize the welding parameters by selecting proper amperage and voltage for the wire diameter and welding position to be used, referring to the A-V range shown in Figure 4 for DW-55L and DW-A55L of 1.2 and 1.4 mm ϕ .

Figure 3: Deposition rates of DW-55L (1.2 and 1.4 mm ϕ) and DW-A55L (1.2 mm ϕ) as a function of welding current.

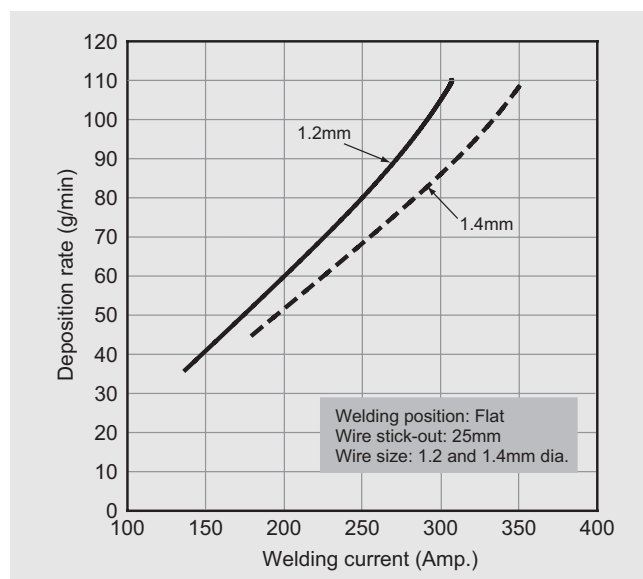
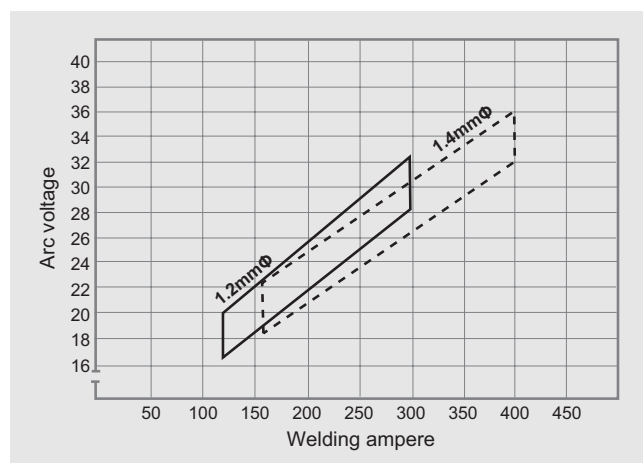

Figure 4: Proper range of welding amperage and arc voltage with DW-55L (1.2 and 1.4 mm ϕ).



Low diffusible hydrogen content assures better weldability

DW-55L and DW-A55L offer low diffusible hydrogen content as shown in Table 2. These measurements are comparable to that of low hydrogen covered electrodes.

Table 2: Typical diffusible hydrogen content of DW-55L (1.2 mm ϕ ; 280A) and DW-A55L (1.2 mm ϕ ; 280A) weld metals tested per JIS Z 3118: Gas Chromatography Method

Trade designation (Shielding gas)	Diffusible hydrogen content (ml/100g)
DW-55L (100%CO ₂)	4.3, 4.7, 4.2, 4.6 (Av. 4.5)
DW-A55L (80%Ar-20%CO ₂)	4.2, 4.7, 4.6, 4.5, (Av. 4.5)

TRUSTARC™ DW-55LSR **TRUSTARC™ DW-A55LSR**
 AWS A5.29 E81T1-K2C AWS A5.29 E81T1-Ni1M

Revolutionary rutile-base flux-cored wires having unsurpassed notch toughness in the SR condition as well as in the as-welded condition at low temperatures down to -60°C and excellent usability in all position welding. Typical applications for DW-55LSR and DW-A55LSR are ships, LPG tanks, offshore structures, and storage tanks.



A typical application for DW-55LSR & DW-A55LSR – LPG tanks with a maximum plate thickness of 40 mm mounted on an LPG carrier requiring local stress relief heat treatment.

How SR affects impact toughness and tensile properties

Stress relief annealing (SR), one type of postweld heat treatment, can relieve residual stresses raised in welds, thereby improving fatigue strength and fracture toughness of the welds. SR, on the other hand, decreases the impact notch toughness of low alloy welds of conventional rutile-base flux-cored wires for low-temperature use. This is because the heat of SR precipitates carbides in the weld metal by combining carbon with, if contained, small amounts of niobium and vanadium, which is known as precipitation hardening. The heat of SR also affects impurities such as phosphorous to diffuse to the grain boundaries of the weld metal, thereby causing embrittlement of the weld, which is referred to as temper embrittlement.

With a sophisticated flux composition design, DW-55LSR (for 100% CO₂ shielding) and DW-A55LSR (for Ar-CO₂ mixture shielding) maintain impact notch toughness as high in the SR condition as in the as-welded condition as shown in Figures 1 and 2. This is the outstanding characteristics of these flux-core wires when compared with conventional rutile-base flux-cored wires.

Figure 1: Charpy impact test results of DW-55LSR and a conventional rutile-base flux-cored wire in the as-welded and SR conditions.

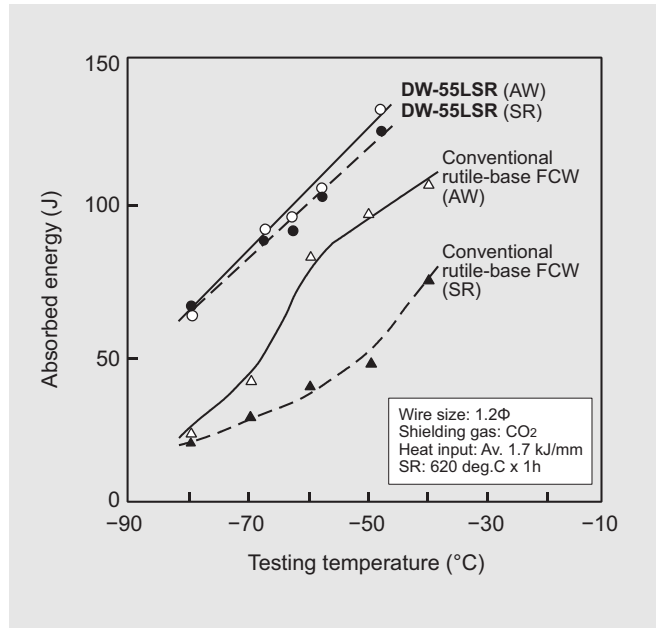
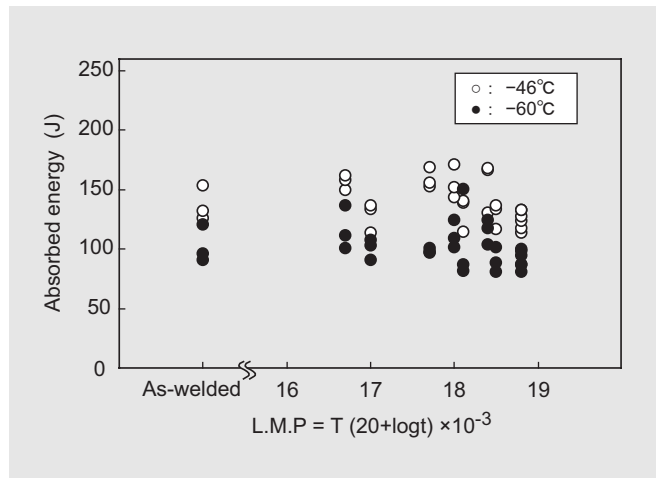
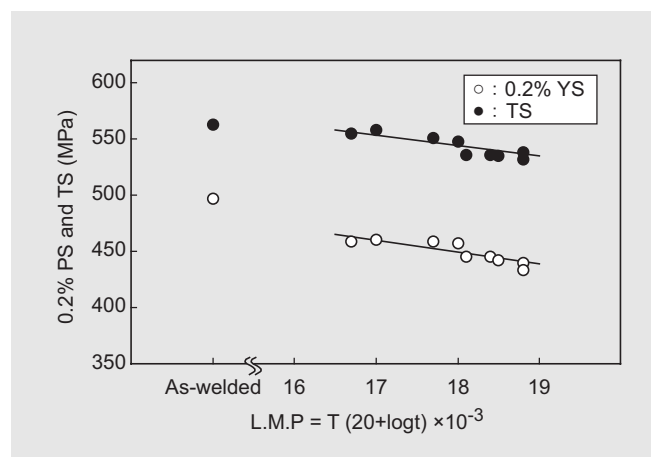

Figure 2: Charpy impact absorbed energies of DW-A55LSR weld metal as a function of SR parameter (L.M.P.: Larson-Miller Parameter).



SR also affects the tensile properties of weld metals by decreasing the yield strength and tensile strength and by increasing the ductility as the Larson-Miller parameter or the product of SR temperature and soaking time increases in the practice range of postweld heat treatment. Figure 3 shows how the 0.2% proof stress and tensile strength of DW-A55LSR weld metal decrease as a function of the SR parameter. From this figure you may know that DW-A55LSR can ensure 550 MPa of tensile strength in the as-welded condition and 520 MPa of tensile strength in the SR condition, as indicated in the selection guide on Page 1.

Figure 3: Tensile properties of DW-A55LSR weld metal as a function of SR parameters (L.M.P: Larson-Miller Parameter).



DW-55LSR and DW-A55LSR offer consistent CTOD values due to fine microstructure

CTOD testing of DW-55LSR and DW-A55LSR weld metals were conducted in accordance with the BS 7448-91 standard, using full size specimens with side notch at the center of the weld metal. DW-55LSR used the 50mm thick base metal JIS G 3106 SM490 A, while DW-A55LSR used the 60mm thick base metal SM490A; both base metals were prepared to have 45-50 degrees double-bevel grooves. The diameter of the wire was 1.2 mmφ for both wires. The welding joints were preheated by 100°C and were kept at the interpass temperature between 100-150°C during welding. The test results are shown in Table 1.

Table 1: CTOD test results of DW-55LSR and DW-A55LSR weld metals in the as-welded condition

Trade designation (Shielding gas)	Welding position	Heat input (kJ/mm)	Test temp. (°C)	CTOD (mm)
DW-55LSR (100%CO ₂)	Horizontal	Av. 0.7	-35	0.37 0.28
	Vertical	Av. 2.0	-35	0.78 0.71
DW-A55LSR (80%Ar-20%CO ₂)	Horizontal	Av. 0.8	-35	0.62 0.63
	Vertical	Av. 1.9	-35	0.75 0.75

Low diffusible hydrogen ensures good cold crack resistance

Diffusible hydrogen is one of the major factors that cause cold cracking of welds. DW-55LSR and DW-A55LSR feature diffusible hydrogen content as low as that of low-hydrogen type covered electrodes, as shown in Table 2. The hydrogen content of weld metals can be varied by the ambient temperature and

humidity as well as welding amperage for the diffusible hydrogen testing.

Table 2: Typical diffusible hydrogen content of DW-55LSR (1.2 mmφ; 250A) and DW-A55LSR (1.2 mmφ; 280A) weld metals tested per JIS Z 3118: Gas Chromatography Method

Trade designation (Shielding gas)	Diffusible hydrogen content (ml/100g)
DW-55LSR (100%CO ₂)	3.6, 3.9, 4.3, 3.3 (Av. 3.8)
DW-A55LSR (80%Ar-20%CO ₂)	3.9, 3.9, 3.9, 3.8 (Av. 3.9)

Control of heat input, preheating and interpass temperatures are essential

In order to prevent cold cracking and assure mechanical properties of weld metals, the control of heat input, preheating and interpass temperatures is indispensable for both DW-55LSR and DW-A55LSR. Table 3 shows how to control such factors in relation to plate thickness of the work and welding position.

Table 3: Proper ranges of heat input, preheating and interpass temperatures where SR is required after welding

Welding position	Plate thick. T (mm)	Heat input (kJ/mm)	Preheat temp. (°C)	Interpass temp. (°C)
F, H	15 ≤ T < 25	1.3-2.0	50 min.	50-150
	25 ≤ T < 30		75 min.	75-150
	30 ≤ T < 40		100 min.	100-150
V-up	15 ≤ T < 25	2.0-3.0	Not req. ⁽¹⁾	150 max.
	25 ≤ T < 30		50 min.	50-150
	30 ≤ T < 40		75 min.	75-150

(1) Where the ambient temperature is 5°C or lower, preheating by 40°C is required.

DW-55LSR and DW-A55LSR exhibits the excellent usability peculiar to rutile-based FCWs

DW-55LSR and DW-A55LSR demonstrates smooth, spatter free arcs, featuring self-peeling slag removal in all position welding. Such excellent usability provides sound welds in every welding position.

TRUSTARC™
DW-A81Ni1
 AWS A5.29 E81T1-Ni1M-J

An innovation in flux-cored wires for low temperature applications such as FPSOs.



A floating production, storage and offloading vessel (FPSO). (Photo courtesy of Fene Shipyard, Italy)

DW-A81Ni1 resembles DW-A55L, sharing a similar rutile-based flux core, suitable shielding gas (80% Ar-20% CO₂), tensile strength and notch toughness of as-welded weld metal. However, their chemical compositions - and thus their AWS classifications - are different, and only DW-A81Ni1 is suited to postweld heat treatment (PWHT). The nickel content of DW-A81Ni1 weld metal is nominally 1% and notch toughness can be kept sufficient even after PWHT.

The low Ni content and PWHT applicability can be advantages in specific fabrications - such as those that adhere to the NACE standard which requires the weldment to be low in Ni content and hardness for minimizing the susceptibility to sulfide stress corrosion cracking (SSCC) that tends to occur in corrosive, aqueous H₂S environments. Such specific fabrications can be involved in offshore structures and floating production, storage and offloading (FPSO) vessels. Many low-alloy steels used in such applications may require PWHT to temper or relieve stresses in the weld to achieve increased ductility.

Table 1 shows typical chemical composition and tensile properties of DW-A81Ni1 welded on high strength FH36 grade steel of the LR ship class. The tensile properties of the weld metal meet the requirements (0.2% PS: 355 MPa min.; TS: 490-620 MPa; El: 21% min.) for this steel grade. Ti-B microalloying is one of the features of the chemical composition of the weld metal, which contributes to fine grain acicular ferrite microstructure (Figure 1) and in turn excellent notch toughness with minimized SR embrittlement as shown in Figure 2 and CTOD values in Table 2.

Table 1: Typical properties of DW-A81Ni1 weld metal ⁽¹⁾

Chemical composition of weld metal (%)							
C	Si	Mn	P	S	Ni	Ti	B
0.05	0.31	1.25	0.008	0.007	0.96	0.04	0.005
Tensile properties of weld metal							
Welding position	PWHT	0.2% PS (MPa)	TS (MPa)	El (%)	RA (%)		
Horizontal	As weld	581	604	25	68		
	580°C x 2h	533	596	26	63		
Vertical	As weld	544	604	27	71		
	580°C x 2h	509	591	30	71		

(1) Specimen location: final side

Figure 1: Fine microstructures of DW-A81Ni1 as-welded weld metal on the final side in the vertical position.

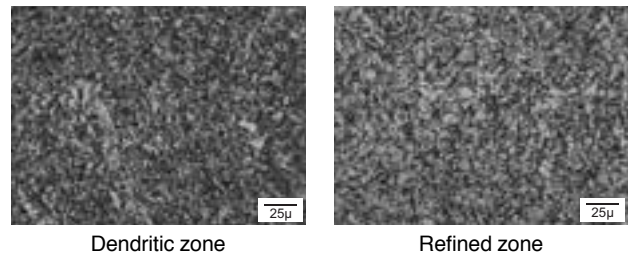

Figure 2: Absorbed energies in Charpy impact testing of DW-A81Ni1 weld metal in the as-welded and PWHT (580°C x 2h) conditions (Base metal: 50mm thick FH36; Groove: double bevel; Specimen location: final side).

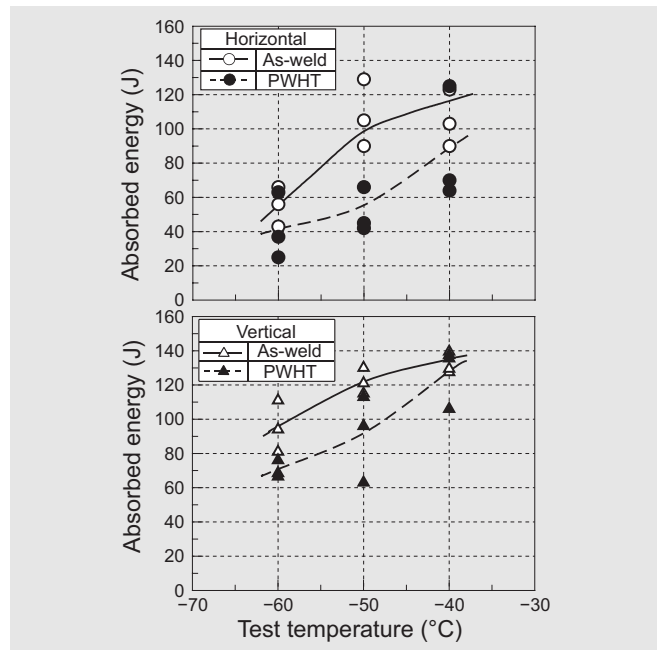

Table 2: CTOD values of DW-A81Ni1 weld metal in the as-welded condition

Base metal	Welding pos.	Test temp.	CTOD (mm) ⁽¹⁾
FH36 t : 50 mm	Horizontal	-10°C	0.38, 0.38, 0.38
	Vertical	-10°C	0.65, 0.76, 0.77

(1) Testing method: BS standard (W = 2B)

TRUSTARC™ TRUSTARC™
DW-62L DW-A62L
AWS A5.29 E91T1-Ni2C-J AWS A5.29 E91T1-GM

Harsh, cold seas require stronger, tougher materials for more durable offshore structures...



...DW-62L and DW-A62L meet the challenge.

(Photo courtesy of Kansai Design Co., Ltd., Japan)

DW-62L (for 100%CO₂ shielding) and DW-A62L (for Ar-CO₂ shielding), innovations in rutile-based flux-cored wires, offer excellent notch toughness suitable for low temperature steel of the 500MPa yield strength class. Both wires provide high notch toughness at -60 °C or higher by Charpy impact testing and stable fracture at -40 °C or higher by CTOD testing.

As shown in Table 1, both wires contain Ni at around 2% and micro-alloying with Ti and B. This sophisticated chemistry of the weld metal enables fine microstructures even in the as-cast zone or dendritic zone - Figure 1.

Table 1: Typical chemical compositions and tensile properties of DW-62L and DW-A62L weld metals tested per AWS A5.29

Trade designation	DW-62L	DW-A62L
C (%)	0.08	0.07
Si (%)	0.27	0.32
Mn (%)	1.32	1.33
Ni (%)	2.6	2.1
Ti (%)	0.05	0.07
B (%)	0.004	0.005
0.2%PS (MPa)	601	561
TS (MPa)	660	641
EI (%)	25	27
Shielding gas	CO ₂	80%Ar-20%CO ₂

Figure 1: Ti-B micro-alloyed fine microstructures of DW-62L (left) and DW-A62L (right) weld metals.

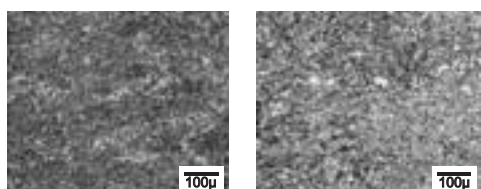

With Ti-B micro-alloyed fine microstructure, DW-62L and DW-A62L exhibit unsurpassed notch toughness as shown in Figure 2 and excellent CTOD values as shown in Table 2.

Figure 2: Charpy impact absorbed energies of weld metals tested with 60mm thick double-V groove joints and 1.2 mmφ wires in vertical welding.

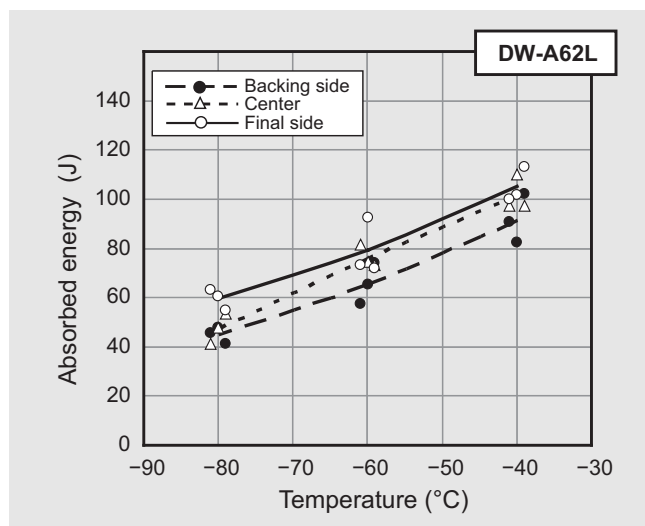
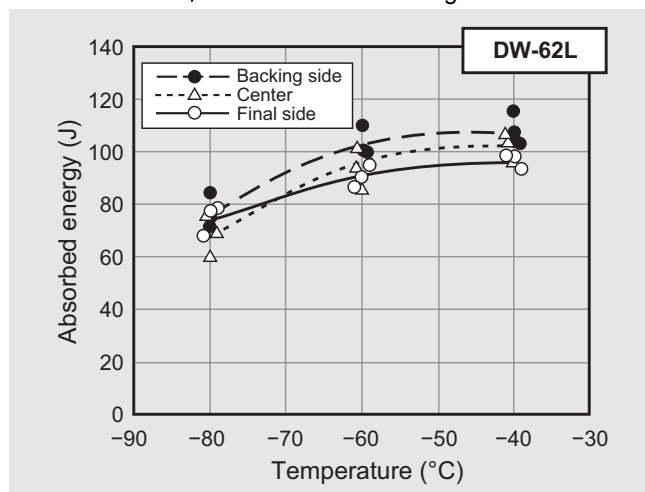

Table 2: CTOD values of DW-62L and DW-A62L weld metals welded in the vertical position (1)

Trade desig. (Shielding gas)	Plate thick. (mm)	Test temp. (°C)	Fracture type	CTOD (mm)
DW-62L (100%CO ₂)	60	-40	Stable fracture	0.72
			Stable fracture	0.63
DW-A62L (80%Ar-20%CO ₂)	80	-40	Stable fracture	0.66
			Stable fracture	0.51
			Stable fracture	0.49

(1) Base metal: Rolled steel of JIS G 3106 SM490A grade. Testing method: BS7448-1991 (W = B).

Diffusible hydrogen testing per JIS Z 3118 resulted in 2.1 ml/100g on average for DW-62L weld metal and 3.9 ml/100g on average for DW-A62L weld metal. Such low diffusible hydrogen enables the use of 100°C preheating to prevent cold cracking in thick plate welds.



Because SMAW is inefficient and requires a rather high level of skill, the development of all-position rutile type flux cored wires (FCWs) has been desired. However, rutile type FCWs deposited weld metals with higher oxygen content and more oxide inclusions than those of SMAW in general, resulted in poor notch toughness. DW-A80L (AWS A5.29 E111T1-GM-H4) provides a solution by controlling the oxygen content in the flux while maintaining high notch toughness. The diffusible hydrogen content with DW-A80L is around 2.5ml/100g, as shown in Table 1, an extremely low level for a rutile type FCW.

Table 1: Diffusible hydrogen content (ml/100g)

N=1	N=2	N=3	N=4	Average
2.5	2.3	2.3	2.7	2.4

Note: Test method: According to AWS A4.3 (Gas chromatography)
 Welding parameters: 265A-28V-300mm/min
 Wire stick out: 20mm; Shielding gas: 80%Ar-20%CO₂

Butt joint welding with DW-A80L on HT780MPa class steel was conducted in the vertical upward position (3G) and horizontal position (2G). Tables 2 and 3 show the test conditions and the tensile properties; Figures 1 and 2, the macrostructures; and Figures 3 and 4, the notch toughness transition curves in 3G and 2G positions respectively.

Table 2: Test conditions of butt joint welding (DW-A80L: 1.2mm dia.)

Test plate	HT780MPa class steel; 50mm thick	
Welding position	Vertical upward (3G)	Horizontal (2G)
Groove preparation	Double V (40° & 60°)	Double bevel (50° & 60°)
Welding parameters	180-200A, 23-24V	220-260A, 25-28V
Heat input	1.7 kJ/mm	1.0 kJ/mm
Shielding gas	80%Ar-20%CO ₂ , 25 l/min	
Preheating temperature	100°C	
Interpass temperature	100-150°C	
PWHT	As-welded	

Table 3: Tensile properties of butt joint weld metals

Welding position	Location	Tensile properties		
		0.2%PS (MPa)	TS (MPa)	EI (%)
3G	Final	736	811	23
	Center	807	856	23
	Back	738	817	24
2G	Final	776	814	19
	Center	833	863	18
	Back	808	843	20

Figure 1: Macrostructure in 3G position

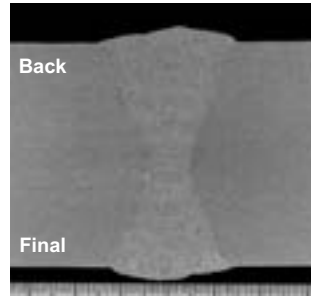

Figure 2: Macrostructure in 2G position

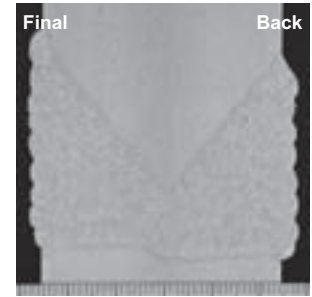

Figure 3: Notch toughness transition curve in 3G position

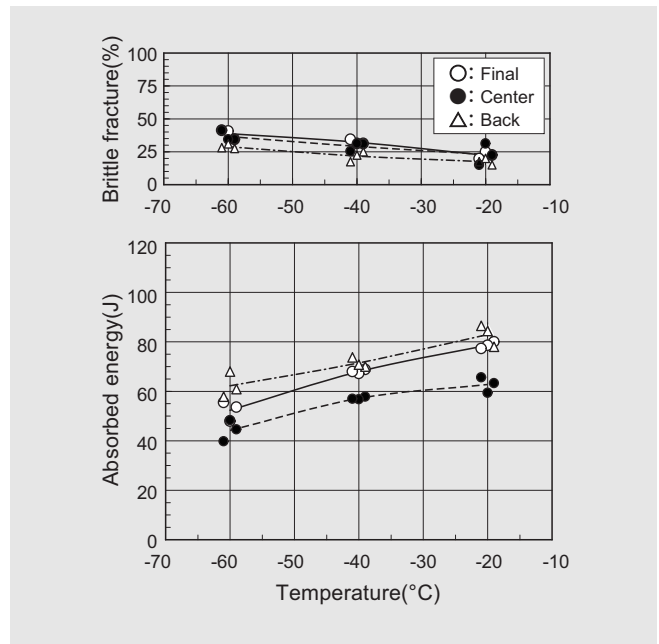
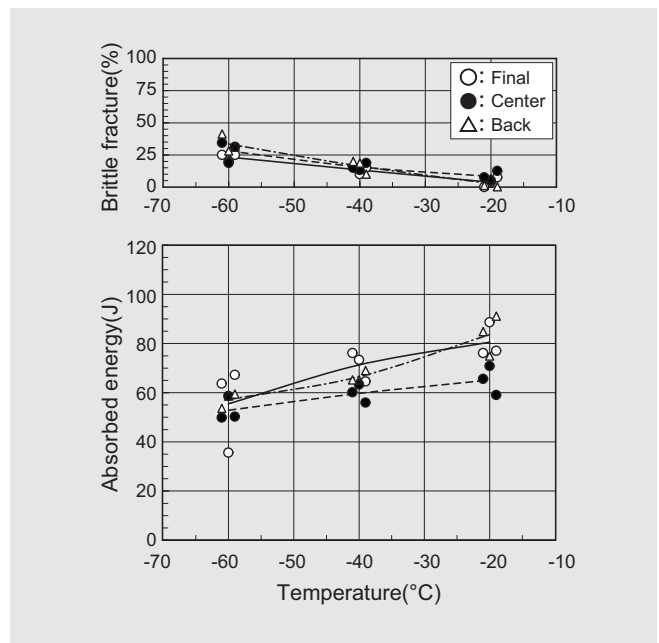

Figure 4: Notch toughness transition curve in 2G position





MX-A80L is a metal-cored wire applied to YS690MPa class high strength steels. It provides good mechanical properties and crack resistance. These properties are reported as follows.

MX-A80L satisfies the following requirements.

- Power source and polarity : DC-EP
- PWHT : None (As-welded)
- 0.2% proof stress : $\geq 690\text{MPa}$
- Tensile strength : $\geq 770\text{MPa}$
- Notch toughness : $\geq 47\text{J}$ at -60°C

Table 1: Diffusible hydrogen content (ml/100g)

N=1	N=2	N=3	N=4	Average
1.2	1.3	1.1	1.2	1.2

Note: Test method: According to AWS A4.3 (Gas chromatography)
Welding conditions: 265A-29V-300mm/min.,
Wire stick out: 20mm; Shielding gas: 80%Ar-20%CO₂

Table 2: Test conditions of butt joint welding
(MX-A80L: 1.2mm dia.)

Test plate	HT780MPa class steel; 50mm thick	
Welding position	Flat (1G)	Horizontal (2G)
Groove preparation	Double bevel (50° & 60°)	
Welding parameters	280A, 32V	260A, 30V
Heat input	1.8 kJ/mm	1.0 kJ/mm
Shielding gas	80%Ar-20%CO ₂ , 25 l/min	
Preheating temperature	100°C	
Interpass temperature	100–150°C	
PWHT	As-welded	

Table 3: Tensile properties of butt joint weld metals

Welding position	Location	Tensile properties		
		0.2%PS (MPa)	TS (MPa)	EI (%)
Flat (1G)	Final	699	776	23
	Center	754	791	24
	Back	707	830	21
Horizontal (2G)	Final	781	820	20
	Center	803	834	22
	Back	821	851	20

Figure 1: Macrostructure in 1G position

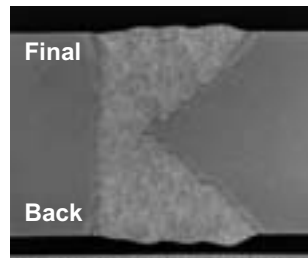

Figure 2: Macrostructure in 2G position

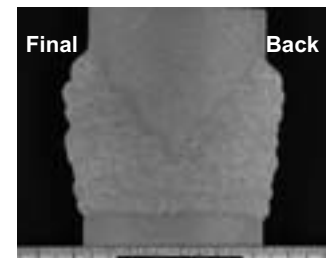

Figure 3: Notch toughness transition curve in 1G position

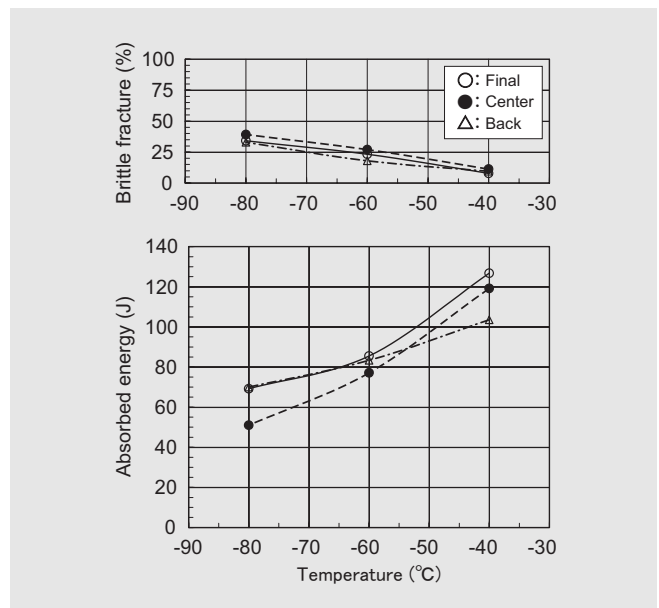
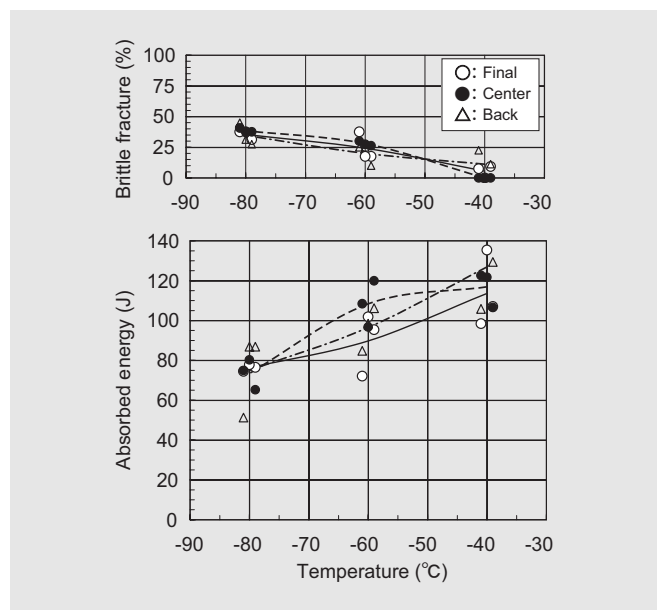
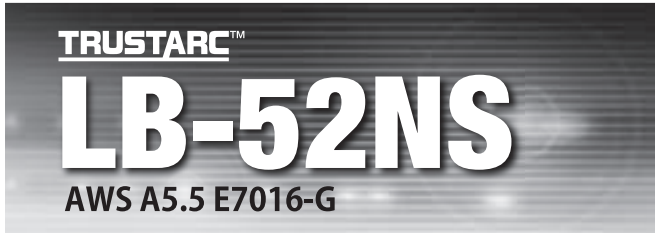

Figure 4: Notch toughness transition curve in 2G position





LB-52NS is a highly reputed, dependable electrode for various low temperature applications such as LPG carriers and storage tanks, offshore structures, and heat exchangers, when the service temperature is down to -60°C .

What characteristics of LB-52NS do the users count on?

The most important quality of the electrodes used in low-temperature applications is weld notch toughness sufficient enough to prevent brittle fractures in the component materials under severe service conditions. Notch toughness, however, is commonly affected by such variables in welding as heat input, plate thickness, cooling speed, welding position, and postweld heat treatment.

LB-52NS ensures adequate notch toughness over a wide range of these variables. In addition, specific technical data such as Crack Tip Opening Displacement (CTOD) and Sulfide Stress Corrosion Cracking (SSCC) are available, which are sometimes required for special applications. Such dependable performance and technical data helps users control the welding quality.

LB-52NS accommodates higher heat input

Heat input is electric energy applied to a weld, which is determined by welding current, arc voltage, and carriage speed. Higher heat input commonly causes coarse microstructure, thereby decreasing notch toughness. LB-52NS, however, can maintain fine microstructure with higher heat input compared to conventional electrodes, due to the specific chemical composition (Si-Mn-0.5Ni-Ti-B). Figure 1 shows the notch toughness of LB-52NS weld metals as a function of heat input. The lowest line of the absorbed energies at -45°C in the figure suggests that heat input can be up to 4.5 kJ/mm to ensure adequate notch toughness. As to those at -60°C , the maximum heat input can be 3.5 kJ/mm to ensure adequate notch toughness. In addition, this figure shows that the notch toughness of LB-52NS weld metal is not deteriorated by SR.

Figure 1: Charpy impact absorbed energy of LB-52NS weld metals as a function of heat input in welding thick-section butt joints.

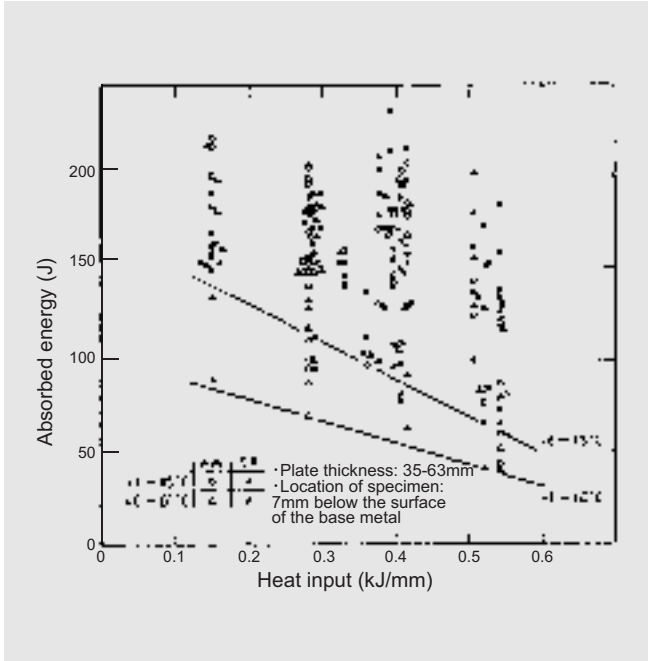

LB-52NS ensures adequate notch toughness even in thinner plates

In welding thinner plates, the microstructure of the weld commonly tends to be coarse because the cooling speed becomes slower and the required number of weld passes decreases – thus the pass-to-pass refining effect on the weld metal microstructure reduces. Figure 2 shows Charpy impact test results of LB-52NS weld metals with three different plate thicknesses using the groove preparation and weld pass sequence shown in the figure.

It is obvious that LB-52NS provides adequate notch toughness, even in the severe condition of vertical-up welding, over a range of plate thicknesses, although with thinner base metal, notch toughness is lower with almost the same heat input. This is because the thinner the base metal, as shown in Table 1, the slower the cooling speed. Slower cooling speeds can cause coarse microstructure at lower or higher rates according to the exact plate thickness used, thereby decreasing notch toughness.

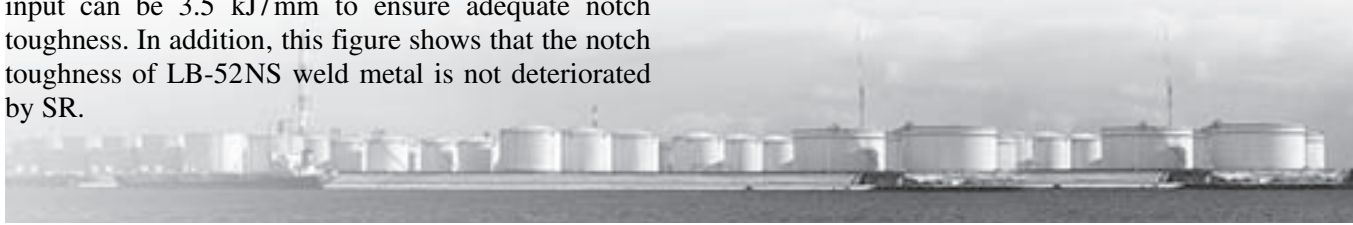

Figure 2: Charpy impact test results of LB-52NS (4 mm ϕ) weld metals in vertical-up AC welding (interpass temperature: 100–150°C).

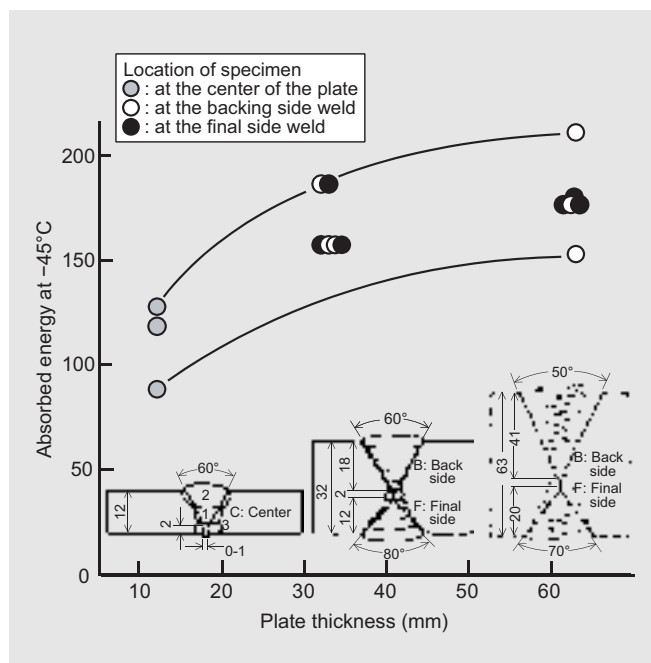

Table 1: Plate thickness, heat input and cooling speed in Charpy impact test of LB-52NS weld metals

Plate thickness (mm) ⁽¹⁾	Average heat input (kJ/mm)	Average cooling speed at 540°C (°C/sec.) ⁽²⁾
12	3.8	1.2
32	4.0	7.6
63	4.0	9.6

(1) For pass sequence, refer to Figure 2.

(2) Cooling speed was calculated by using a Rosenthal formula.

LB-52NS maintains adequate tensile strength over extended PWHT

In welding fabrication of thick-section pressure vessels, postweld heat treatment (PWHT) is indispensable to relieve residual stresses raised by welding. As with typical ferritic weld metals, the tensile strength and yield strength of LB-52NS weld metal decrease as the temper parameter (Larson-Miller Parameter) or the product of PWHT temperature and soaking time increases, reducing residual stresses. However, LB-52NS maintains adequate tensile strength and yield strength even after extended PWHT as shown in Figure 3. This preferable characteristic is derived from fine-microstructure weld metal provided by the sophisticated design of chemical composition as previously mentioned.

Figure 3: Effect of PWHT conditions on tensile properties of LB-52NS deposited metal.

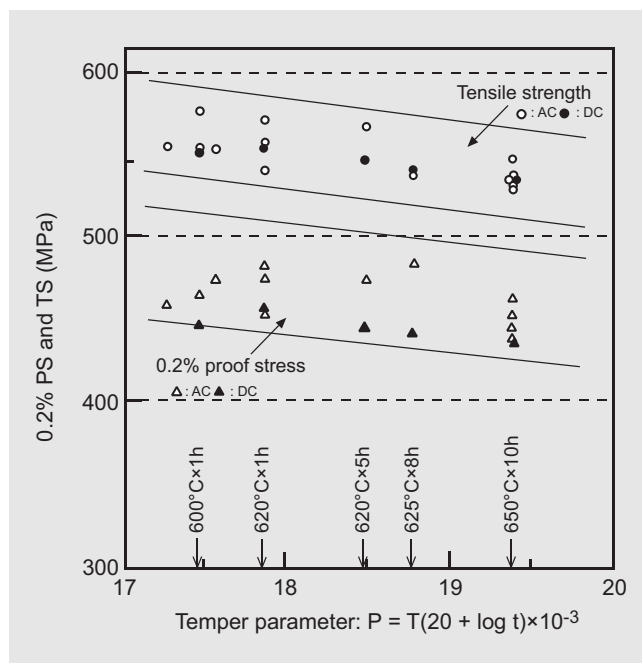

LPG storage tank is typical application for LB-52NS

Liquefied petroleum gas (LPG) is stored at a low temperature of -45°C in thermal-insulated LPG storage tanks. Therefore, materials including weld metal of the tank must have adequate notch toughness at that temperature. In construction of a cylindrical LPG tank, in addition to automatic processes (SAW, GTAW), LB-52NS is an indispensable electrode featuring unsurpassed quality including usability in out-of-position welding and resistance to cold cracking and moisture pick-up.

Figure 4: Cylindrical LPG storage tank is a typical application for LB-52NS.



TRUSTARC™
NB-1SJ
 AWS A5.5 E8016-G

In welding low-temperature high-strength steels having a minimum tensile strength of 490-550 MPa, NB-1SJ is one of the best selections. LPG storage tanks, offshore structures in cold districts, and other low-temperature use equipment are typical applications for NB-1SJ.



A flat-bottomed cylindrical single shell tank for storing liquefied butane gas is one recent application for NB-1SJ, when constructed per BS7777 specification requiring -50°C notch toughness based on fracture mechanics (Photo courtesy of Toyo Kanetsu K.K., Japan).

NB-1SJ offers consistent impact absorbed energy and tensile strength

Notch toughness is an indispensable quality of the materials used in low-temperature equipment to protect the constructions from brittle fractures under strict service conditions. The impact absorbed energy of weld metals, however, is prone to scatter caused by such variables as heat input, welding position, plate thickness, cooling speed, and postweld heat treatment. This is because these variables affect the microstructure of the weld metal.

The exquisite design of the chemical composition of NB-1SJ facilitates consistent mechanical properties of the weld metal. Approximately 1.4% Ni and strictly controlled amounts of titanium (Ti) and boron (B) are the noticeable factors to stabilize the weld metal mechanical properties shown in Figure 1 for Charpy impact toughness and in Figure 2 for tensile strength. The typical macrostructure of the test joints and locations of test specimens are shown in Figure 3. As shown in Figure 1, the impact absorbed energies are in a decreasing tendency as the heat input increases. This is because the use of high heat input causes coarse-grained microstructures of weld metals. In addition to

this, postweld heat treatment or stress relief annealing (SR) causes a decrease in notch toughness because of SR embrittlement. However, NB-1SJ weld metal maintains adequate absorbed energies at both -60 and -45°C in the as-welded and PWHT conditions in out-of-position welding.

As shown in Figure 2, the tensile strength is apt to decrease as the heat input becomes higher, because the use of high heat input causes coarse-grained microstructures of weld metals. Furthermore, postweld heat treatment causes a decrease in tensile strength as a result of stress relieving of the weld metal. However, NB-1SJ weld metal maintains adequate tensile strength over the minimum tensile strength (550 MPa) of A537 Cl-2 steel in the as-welded and PWHT conditions in all-position welding.

Figure 1: Charpy impact absorbed energies of NB-1SJ weld metals as a function of heat input in the as-welded and postweld heat treated ($600^{\circ}\text{C} \times 2\text{h}$) conditions (Each plot is the average of three specimens).

- Base metal: 32mm thick A537 Cl.2, double-V groove
- Heat input: Av. 2.5 kJ/mm (Flat); Av. 3.7, 3.7, 4.6 and 4.7 kJ/mm (Vertical); Av. 1.6 and 1.7 kJ/mm (Horizontal)
- Power source: AC

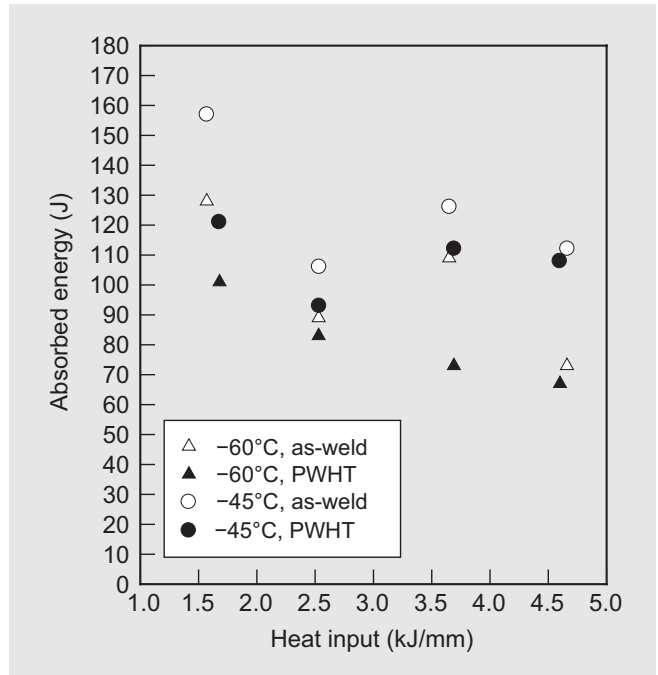

Figure 2: Tensile strength of NB-1SJ weld metal as a function of heat input in the as-welded and postweld heat treated (600°C × 2h) conditions.

- Base metal: 32mm thick A537 Cl.2, double-V groove
- Heat input: Av. 2.5 kJ/mm (Flat); Av. 3.7, 3.7, 4.6 and 4.7 kJ/mm (Vertical); Av. 1.6 and 1.7 kJ/mm (Horizontal)
- Power source: AC

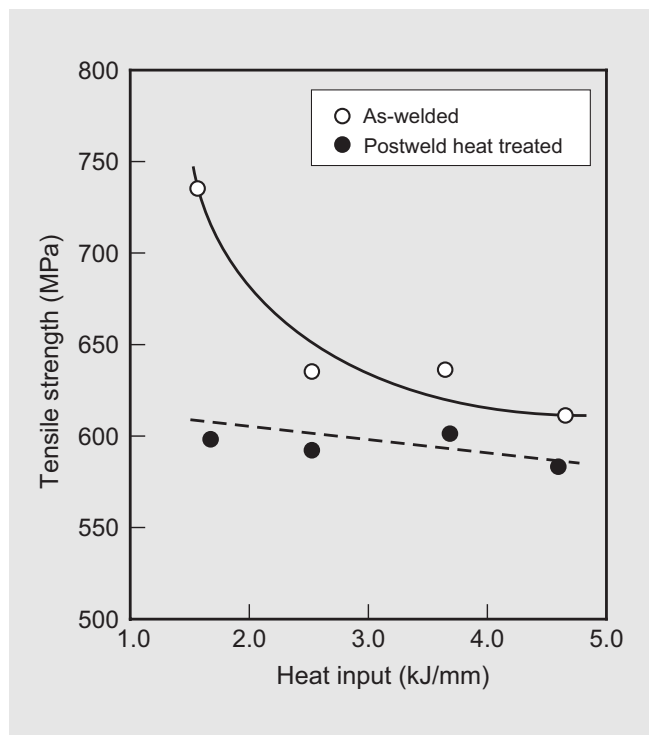
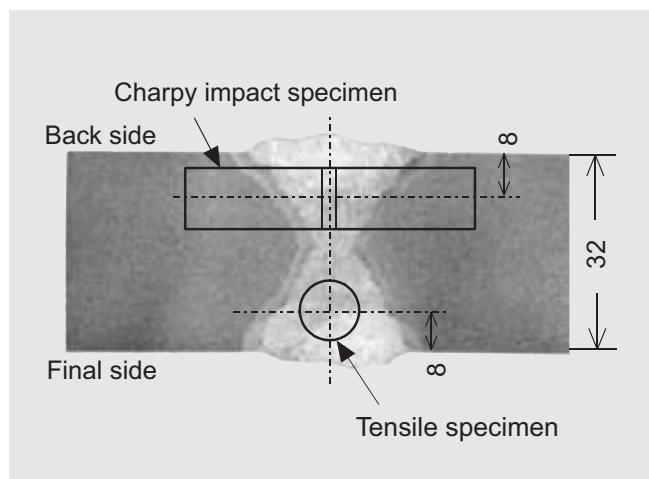

Figure 3: Macroscopic structure of test joint and locations of test specimens (Flat position).



Sufficient CTOD values exhibit excellent fracture toughness of NB-1SJ

NB-1 SJ features high CTOD values at low temperatures down to -45°C in the as-welded condition over variables of welding position and heat input, as shown in Table 1. CTOD test has been used mainly for carbon-manganese steels and low alloy steels in the ductile/brittle transition temperature range, and has found much use in weld procedure tests for work on North Sea offshore structures.

Table 1: CTOD test results of NB-1SJ weld metals in the as-welded condition using a 32mm thick A537 Cl.2 base metal having a double-V groove ⁽¹⁾

Welding position	Heat input (kJ/mm)	Testing temp. ($^{\circ}\text{C}$)	CTOD (mm)
Flat	Av. 2.5	-46	0.69
			0.70
			0.74
Vertical	Av. 3.7	-46	0.69
			1.20
Vertical	Av. 4.7	-46	0.22
			0.55
Horizontal	Av. 1.6	-46	1.36
			0.85
			0.21

(1) The CTOD test was conducted in accordance with BS5762-1979 (three-point bending), using the test specimen as shown below. In this test, the crack tip opening displacement was measured by using the clip gauge to determine the fracture toughness of the weld.

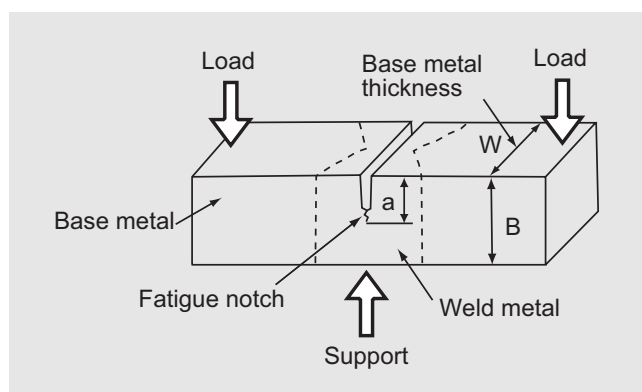

How to select NB-1SJ and LB-62L for welding A537 Cl-2 Steel

Both NB-1SJ and LB-62L (Refer to Page 7 for the details of LB-62L) are suitable for welding ASTM A 537 Cl-2 (Tensile strength: 550 MPa min.) or other equivalent steels. The lowest temperature at which NB-1SJ can ensure sufficient notch toughness is -80°C , while -60°C for LB-62L. Both electrodes can inherently be used with both AC and DCEP current. However, when it comes to the guarantee of such a high tensile strength over a wide range of welding variables encountered in fabrication sites, the type of welding current is a critical factor. Therefore, select NB-1SJ for AC current and LB-62L for AC or DCEP current. This is because the type of current affects the yield of chemical elements in weld metals and, in turn, affects mechanical properties of weld metals. The use of DCEP generally decreases the tensile strength of weld metals.

TRUSTARC™
LB-62L
 AWS A5.5 E8016-C1

LB-62L: the best choice for welding ASTM A537 Cl.2 or other equivalent types of steel for low-temperature service. LPG spherical tanks are typical applications for LB-62L.



Some types of LPG storage tanks use ASTM A537 Cl.2 steel having a minimum tensile strength of 550 MPa, and LB-62L is one of the most suitable covered electrodes for this steel.

Steady notch toughness and tensile strength are dependable characteristics of LB-62L

Notch toughness is one of the most important qualities of materials used in low-temperature equipment because it offers resistance against brittle fractures under severe service conditions. Weld notch toughness, however, is commonly affected by variables encountered in welding: heat input, plate thickness, cooling speed, welding position and postweld heat treatment.

LB-62L ensures sufficient notch toughness at low temperatures down to -60°C over a wide range of such variables. Figure 1 shows Charpy impact absorbed energies of the weld metal as a function of heat input. The test results show a slight decrease with an increase in heat input. However, the weld metal maintains an adequate level of absorbed energy over the range of heat input.

Figure 2 shows how the strength of the weld metal depends on the cooling speed in welding. Both the tensile strength and 0.2% proof stress are prone to decrease little by little as the cooling speed decreases.

Table 1 shows the plate thickness and heat input corresponding to the cooling speeds shown in Figure 2.

Figure 1: Impact absorbed energies of LB-62L (4.0 mm ϕ) weld metals as a function of heat input in welding double-V groove joints in flat, horizontal and vertical-up positions (As-weld; Power source: AC).

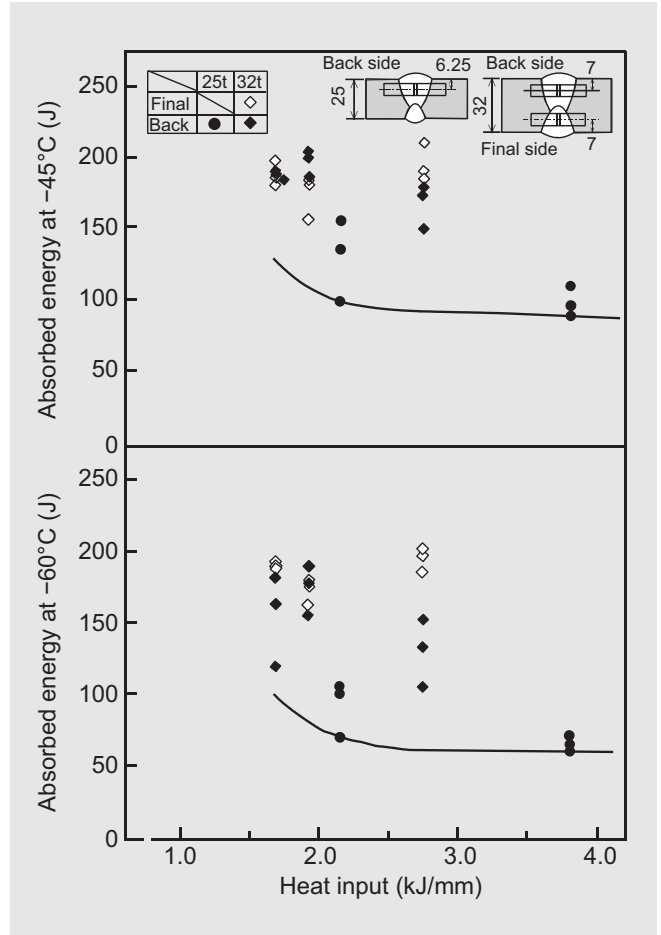
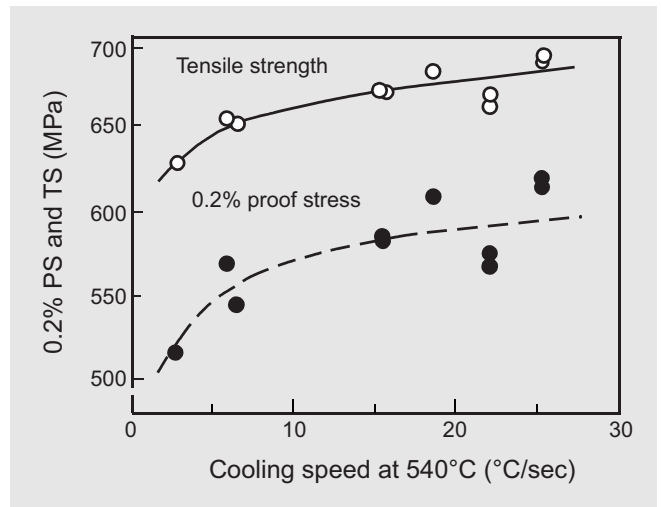

Figure 2: Strengths of LB-62L (4 mm ϕ) weld metals vs. cooling speeds (As-weld; Power source: AC).



In general, the cooling speed decreases in uses of a thinner base metal and a higher interpass temperature when the heat input is kept constant. Therefore, in

order to attain the targeted weld quality, the heat input and interpass temperature should properly be controlled according to the thickness of the base metal and the required qualities for the weld.

Table 1: Welding conditions (No preheat)

Cooling speed at 540°C (°C/sec)	Plate thickness (mm)	Average heat input (kJ/mm)	Welding position
2.8	12	2.7	Vertical up
5.9	25	3.8	Vertical up
6.4	12	1.7	Flat
15.3	32	2.7	Vertical up
18.4	25	2.2	Flat
22.0	32	1.9	Flat
25.2	32	1.7	Horizontal

LB-62L maintains adequate tensile strength over extended PWHT

Some weld joints where residual stresses are prone to concentrate (e.g. a crown plate to nozzle weld joint of a spherical tank) require postweld heat treatment (PWHT). As usual with ferritic weld metal, the strength of LB-62L weld metal decreases as PWHT temperature and soaking time increase. However, LB-62L weld metal maintains adequate tensile strength over the minimum tensile strength (550N/mm²) of A 537 Cl.2 steel even after extended PWHT as shown in Figure 3. In addition, some types of weld metal lose notch toughness due to embrittlement caused by PWHT. LB-62L weld metal, however, maintains adequate notch toughness even after PWHT as shown in Figure 4.

Figure 3: Strength of LB-62L (5.0 mmφ) all-deposited metal vs. PWHT parameter (Power source: DC-EP, Heat input: av. 1.9 kJ/mm, Welding position: flat).

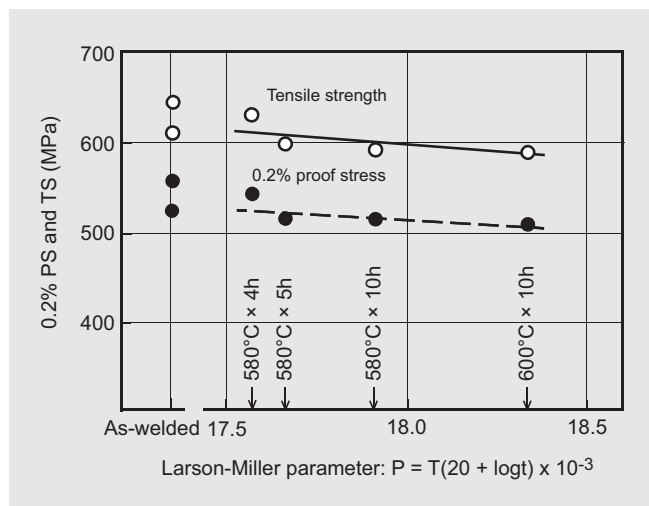
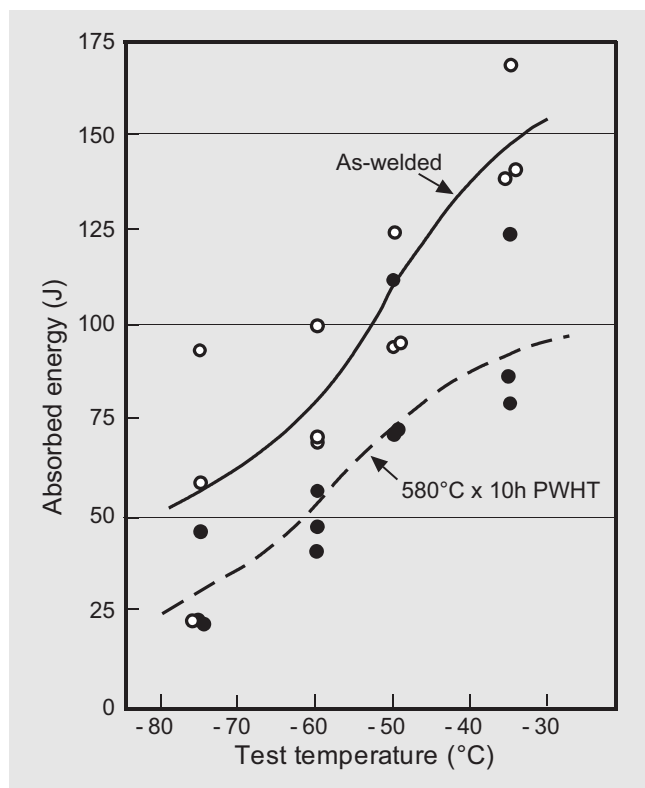

Figure 4: Effect of postweld heat treatment on impact absorbed energy of LB-62L (4.0 mmφ) weld metal (Power source: DCEP; Heat input: av. 3.9 kJ/mm; Welding position: Vertical up; Base metal: A537 Cl.2; Groove preparation: double V).



LB-62L offers extra-low hydrogen and moisture resistant characteristics

LB-62L offers extra-low hydrogen weld metals, which can be used with a lower preheating temperature for preventing cold cracking. In addition, LB-62L picks up less moisture due to its moisture resistant coating when compared with conventional low-hydrogen electrodes (Figure 5). Such outstanding features can make quality control easier and more economical by reducing the costs for preheating the work and redrying the electrode.

Figure 5: Test results of LB-62L and conventional low-hydrogen electrode on moisture pick-up under the controlled atmosphere: 30°C x 80%R.H.

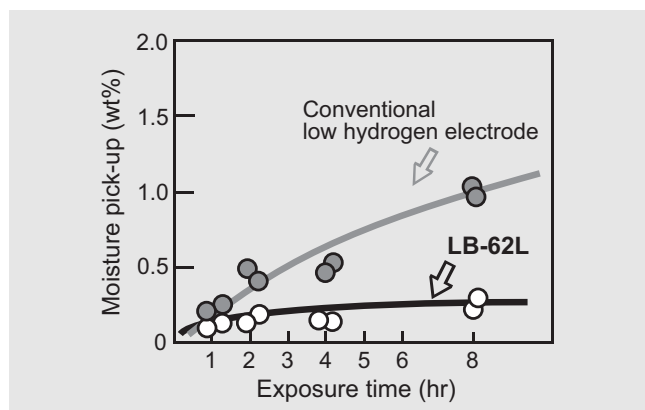

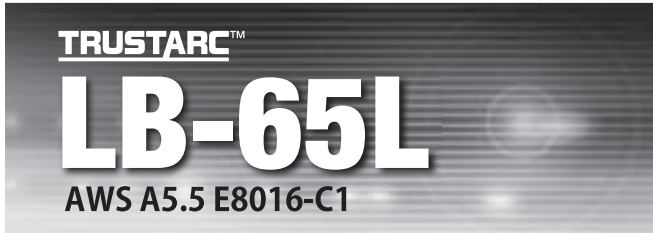

LB-65L: The best selection for DC-spec. electrode for 610 MPa class high strength steel for low temperature applications such as offshore structures and storage tanks.

LB-65L offers consistent tensile strength, notch toughness and CTOD

LB-65L is an extra-low hydrogen covered electrode for the direct current electrode positive (DCEP) polarity, depositing 2.5%Ni-Ti-B weld metals with fine microstructure. It assures consistent tensile strength, impact absorbed energy and crack-tip opening displacement (CTOD) in both the as-welded and postweld heat treated (PWHT) conditions.

Figure 1 shows the yield strength (0.2% proof stress) and tensile strength of LB-65L weld metal at room temperature as a function of the temper parameter of PWHT. It is obvious that LB-65L displays sufficient tensile strengths exceeding 610 MPa in the PWHT range tested.

Figure 1: Tension test results of LB-65L weld metal in the as-welded and postweld heat treated conditions (PWHT/temper parameter: 560°C × 1h/16.66; 580°C × 4h/17.57; 620°C × 1h/17.86; 620°C × 5h/18.48; 620°C × 40h/19.29).

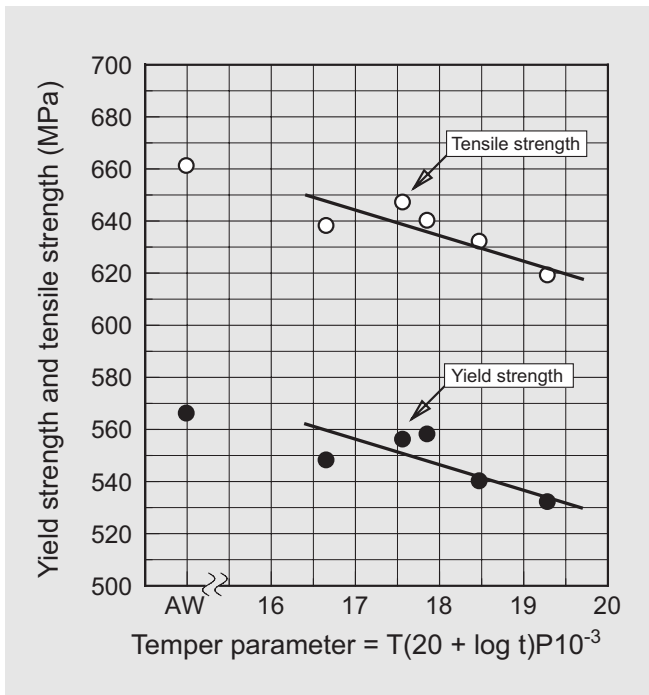

Figure 2 shows the impact absorbed energy of LB-65L weld metal as a function of the temper parameter of PWHT. From these results, it is clear that a minimum of 50J can be assured at -60°C in the PWHT range tested.

Figure 2: Charpy impact test results of LB-65L weld metal in the as-welded and postweld heat treated conditions (PWHT/temper parameter: 560°C × 1h/16.66; 580°C × 4h/17.57; 620°C × 1h/17.86; 620°C × 5h/18.48; 620°C × 40h/19.29).

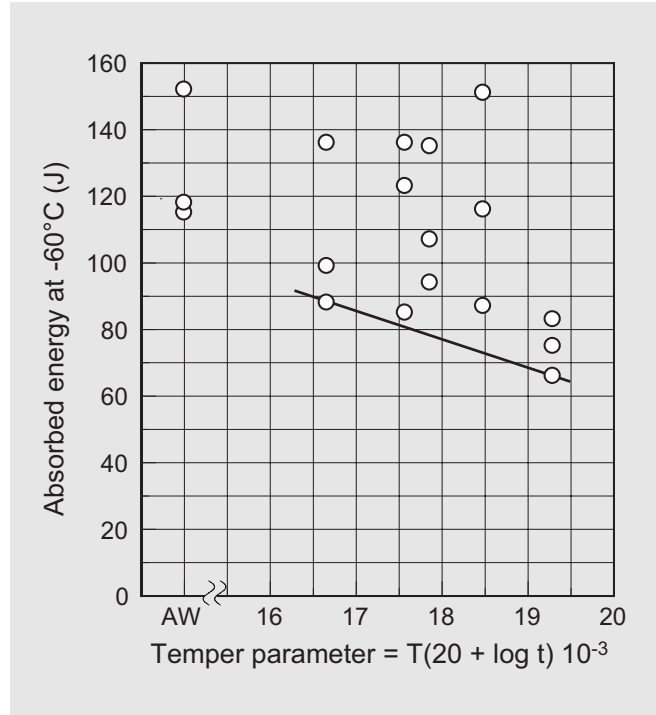

Table 1 shows the CTOD values of LB-65L weld metals obtained in the as-welded condition. Welding was conducted using double-V groove joints of 610MPa high strength steel (K-TEN 610). From these results, it is obvious that 0.5 mm can be ensured at -20°C.

Table 1: CTOD test results of LB-65L weld metal in the as-welded condition using a 25mm thick double-V groove joint of 610MPa rolled high strength steel

Welding position	Heat input (kJ/mm)	Testing temp. (°C)	CTOD ⁽¹⁾ (mm)
Flat	2.0	-21	>1.17
		-21	>1.14
		-45	0.41
		-45	0.11
Vertical	4.1	-20	>1.14
		-20	>1.09
		-44	0.32
		-45	0.46

(1) Testing method: BS7448-91 (Specimen size: W=B)

TRUSTARC™
LB-80L
AWS A5.5 E11018-G H4

Spherical storage tanks, penstock, offshore structures, and bridges of 780 MPa high strength steel are typical applications for LB-80L.



Jack-up rig is a typical construction that requires high performance filler metals with high impact toughness and low crack susceptibility. (Photo courtesy of Kansai Design Co., Ltd., Japan)

For welding YS 690 MPa class steels requiring high notch toughness as well as cold crack resistance at low temperatures, ultra-low hydrogen covered electrodes (low in oxygen as well) still play a major roll. LB-80L (AWS A5.5 E11018-G H4), which was designed for DC welding, satisfies all of these requirements as shown below. Figure 1 shows an example of welding processes for rack portions of jack-up-rigs, where YS 690MPa class steels are mainly used.

Figure 1: Example of welding processes for a rack portion of a jack-up-rig

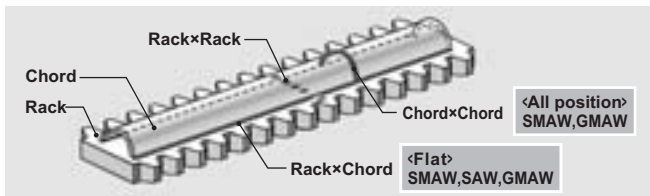

Table 1 shows that diffusible hydrogen in test results of LB-80L is as low as 2.0ml/100g and stable. It is, therefore, regarded as the most reliable welding consumable for cold crack resistance.

Table 1: Diffusible hydrogen content (ml/100g)

N=1	N=2	N=3	N=4	Average
1.9	1.5	1.3	1.7	1.6

Note: Test method: According to AWS A4.3 (Gas chromatography)
Welding current: 150 A (4.0mm dia.; DCEP)

The test conditions and the tensile properties of a butt joint of HT780MPa class steel welded by LB-80L are shown in Tables 2 and 3, and the macrostructure and the notch toughness transition curve, in Figures 2 and 3 respectively.

Table 2: Test conditions of butt joint (LB-80L: 4.0mm dia.)

Test plate	HT780MPa class steel; 50mm thick
Groove preparation	Double V (50° and 70°)
Welding position	Vertical upward (3G)
Welding parameters	120 A-22 V (DCEP)
Heat input	2.0 kJ/mm
Preheating & interpass temperature	150°C

Table 3: Tensile properties of butt joint weld metal

Location	Tensile properties		
	0.2%PS (MPa)	TS (MPa)	EI (%)
Final	773	865	19
Center	807	864	17
Back	753	832	17

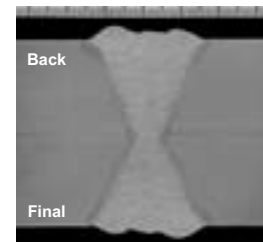
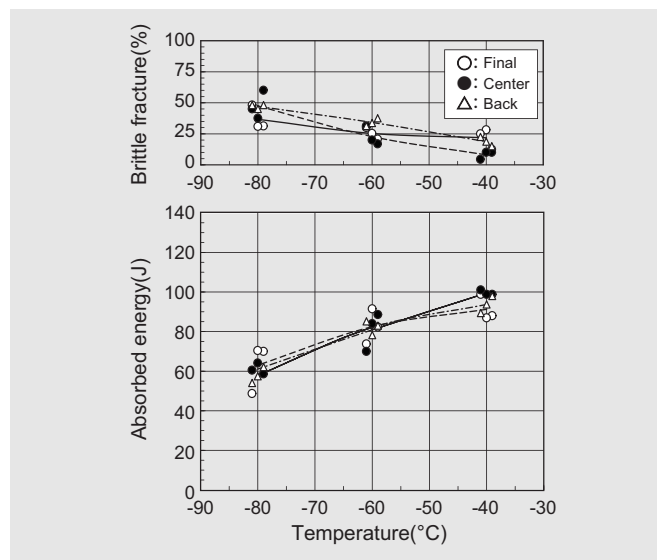

Figure 2: Macrostructure in 3G position

Figure 3: Notch toughness transition curve in 3G position



LB-80L satisfies the following requirements.

- Power source and polarity: DC-EP
- PWHT : None (As-welded)
- 0.2% proof stress : ≥ 690 MPa
- Tensile strength : ≥ 760 MPa
- Notch toughness : ≥ 47 J at -60°C
(※ Recommended heat input: 1.0~2.5kJ/mm)

KOBELCO

THE WORLDWIDE MANUFACTURER

GLOBAL MANUFACTURING AND SALES BASES

ASIA

JAPAN:

KOBE STEEL, LTD., Welding Business
Marketing Dept., International Sales & Marketing Sec.
Tel. (81) 3 5739 6331 Fax. (81) 3 5739 6960

KOREA:

KOBE WELDING OF KOREA CO., LTD.
Tel. (82) 55 292 6886 Fax. (82) 55 292 7786

KOBELCO WELDING MARKETING OF KOREA CO., LTD.
Tel. (82) 51 329 8950 to 8952 Fax. (82) 51 329 8949

CHINA:

KOBE WELDING OF SHANGHAI CO., LTD.
Tel. (86) 21 6191 7850 Fax. (86) 21 6191 7851

KOBE WELDING OF TANGSHAN CO., LTD.
Tel. (86) 315 385 2806 Fax. (86) 315 385 2829

KOBE WELDING OF QINGDAO CO., LTD.
Tel. (86) 532 8098 5005 Fax. (86) 532 8098 5008

SINGAPORE:

KOBELCO WELDING ASIA PACIFIC PTE. LTD.
Tel. (65) 6268 2711 Fax. (65) 6264 1751

THAILAND:

THAI-KOBE WELDING CO., LTD.
Tel. (66) 2 636 8650 to 8652 Fax. (66) 2 636 8653

KOBE MIG WIRE (THAILAND) CO., LTD.
Tel. (66) 2 324 0588 to 0591 Fax. (66) 2 324 0797

MALAYSIA:

KOBE WELDING (MALAYSIA) SDN. BHD.
Tel. (60) 4 3905792 Fax. (60) 4 3905827

INDONESIA:

P.T. INTAN PERTIWI INDUSTRI
(Technically Collaborated Company)
Tel. (62) 21 639 2608 Fax. (62) 21 649 6081

INDIA:

KOBELCO WELDING INDIA PVT. LTD.
Tel. (91) 124 4010063 Fax. (91) 124 4010068

EUROPE

NETHERLANDS:

KOBELCO WELDING OF EUROPE B.V.
Tel. (31) 45 547 1111 Fax. (31) 45 547 1100

AMERICA

USA:

KOBELCO WELDING OF AMERICA INC.
Tel. (1) 281 240 5600 Fax. (1) 281 240 5625

KOBELCO

THE
GUARANTEE:

QTQ

QUALITY PRODUCTS
TECHNICAL SUPPORT
QUICK DELIVERY



International slogan of KOBE STEEL Welding Group